

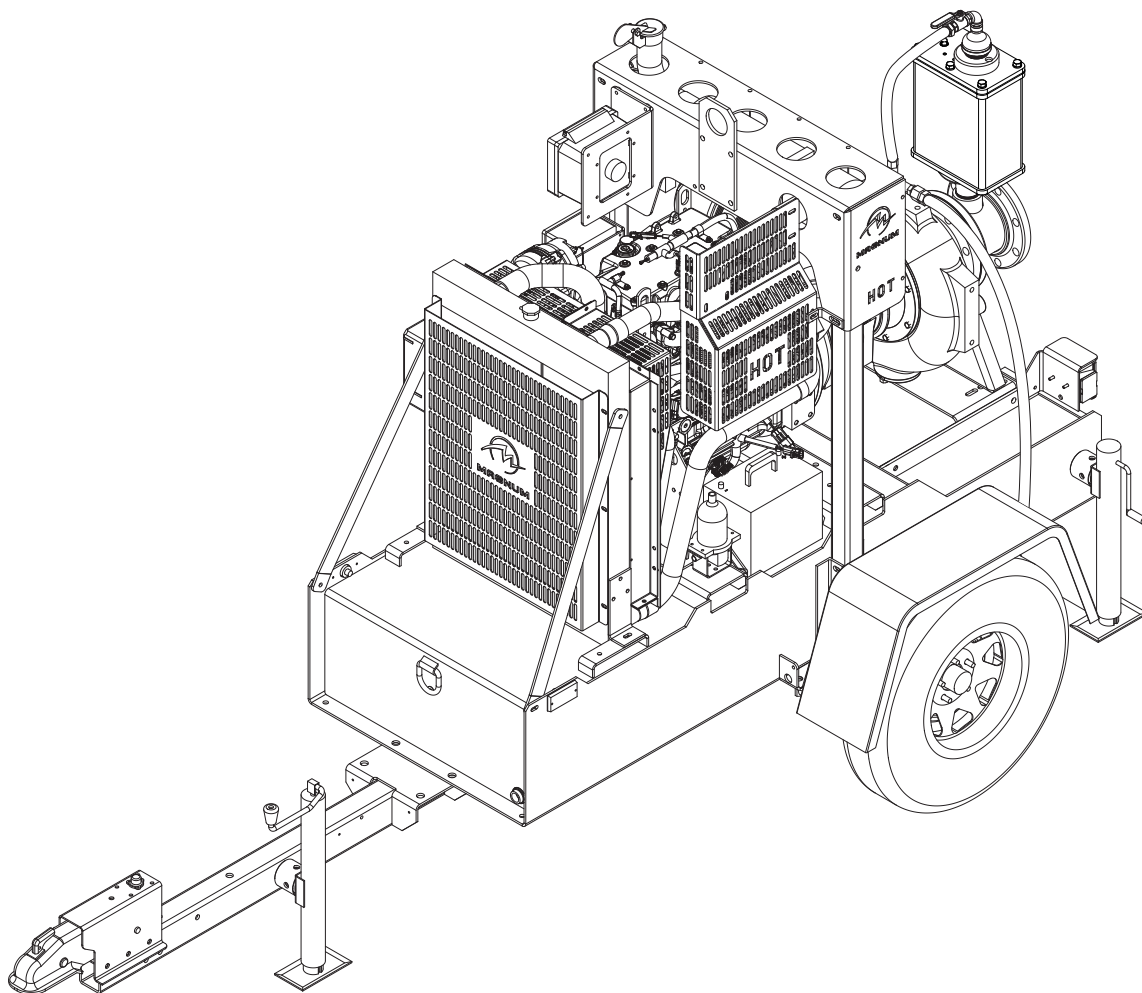

DRY-PRIME DIESEL TRASH PUMP MTP6000D3



OPERATING MANUAL

Parts manuals available online! www.m-p-llc.com

INTRODUCTION

This manual provides information and procedures to safely operate and maintain the engine and pump. For your own safety and protection from physical injury, carefully read, understand, and observe the safety instructions described in this manual. *The information contained in this manual was based on machines in production at the time of publication. Magnum Power Products LLC reserves the right to change any portion of this information without notice.*

DO NOT MODIFY or use this equipment for any application other than which it was designed for.

Magnum Power Products LLC recommends that a trained and licensed professional perform all electrical wiring and testing functions. Any wiring should be in compliance with the United States National Electrical Code (NEC), state and local codes and Occupational Safety and Health Association (OSHA) guidelines.

Keep a copy of this manual with the unit at all times. Additional copies are available from Magnum Power Products LLC, or can be found at www.m-p-llc.com. An engine operator's manual is supplied with the unit at the time of shipment from the factory. The manual provides detailed operation and maintenance procedures for the engine. Additional copies of the engine operator's manual are available from the engine manufacturer.

MAGNUM POWER PRODUCTS LLC

215 Power Drive • Berlin, WI 54923

U.S.A.

Phone: 920-361-4442

FAX: 920-361-4416

Toll Free: 1-800-926-9768

www.m-p-llc.com

For technical or parts **QUESTIONS**, please contact the Magnum Power Products LLC Customer Support or Technical Support team at 1-800-926-9768. Please have your serial number available.

To **ORDER SERVICE PARTS**, please contact the dealer from which you purchased the unit, or call Magnum Power Products LLC to locate a dealer in your area.

Engine Make: _____

Engine Serial Number: _____

Engine Model Number: _____

Pump Make: _____

Pump Model Number: _____

Pump Serial Number: _____

Unit Model Number: _____

Unit Serial Number: _____

▲ WARNING

CALIFORNIA PROPOSITION 65 WARNING: Diesel engine exhaust and some of its constituents are known to the state of California to cause cancer, birth defects and other reproductive harm.

TABLE OF CONTENTS

	Page
INTRODUCTION.....	2
SAFETY NOTES.....	4
OPERATING SAFETY.....	4
ENGINE SAFETY.....	5
PUMP SAFETY.....	5
SERVICE SAFETY.....	6
TOWING SAFETY.....	6
REPORTING TRAILER SAFETY DEFECTS.....	7
UNIT SERIAL NUMBER LOCATIONS.....	7
SAFETY SYMBOL SUMMARY.....	8
SPECIFICATIONS.....	9
COMPONENT LOCATIONS.....	10
CONTROL PANEL.....	12
CONTROL PANEL OPERATION.....	13
THROTTLE CONTROL.....	13
RAMP THROTTLE (SPEED CONTROL SWITCH).....	13
CANPLUS DISPLAY.....	14
ANALOG GAUGE PAGES.....	14
DIGITAL GAUGE PAGES.....	15
SINGLE ANALOG GAUGE.....	15
ACTIVE ALARMS.....	15
ALARM LIST.....	16
CONFIGURATION.....	16
CONFIGURATION MENU.....	16
DISPLAY MENU.....	17
SYSTEM MENU.....	18
THROTTLING MENU.....	22
TELEMETRY MENU.....	23
DB VIEWER.....	24
PREFERRED SCREEN STORE.....	24
POPUP MESSAGES AND ALERTS.....	24
ADJUSTING LIGHTING AND CONTRAST.....	25
DATA PARAMETERS MONITORED.....	25
ENGINE BREAK-IN REQUIREMENTS.....	27
PUMP PRE-USE CHECKPOINTS.....	27
PUMP SET UP.....	28
STARTING THE PUMP.....	29
SUCTION SPECIFICATIONS.....	30
STOPPING THE PUMP.....	31
AUTOMATIC SHUTDOWN.....	31
REMOTE/AUTO STARTING OPTION.....	31
TOWING THE TRAILER.....	31
TRAILER WHEEL BEARINGS.....	32
LIFTING THE PUMP.....	32
DAILY WALK AROUND INSPECTION.....	32
ENGINE AND PUMP MAINTENANCE.....	32
BASIC MAINTENANCE SCHEDULE (JOHN DEERE ENGINE).....	33
BELT TENSIONERS.....	34
SERVICING THE PUMP.....	34
PUMP MAINTENANCE PROCEDURES.....	35
STORAGE.....	42
PUMP TROUBLESHOOTING.....	43
ENGINE FAULT SHUTDOWN TROUBLESHOOTING.....	44
CONTROL SYSTEM TROUBLESHOOTING.....	45
PUMP COMPONENT DRAWING.....	46
DC WIRING DIAGRAM.....	47
TRAILER LIGHTS WIRING DIAGRAM.....	48
SERVICE LOG.....	49
NOTES.....	50

SAFETY NOTES



This is the safety alert symbol. It is used to alert you to potential personal injury hazards. Obey all safety messages that follow this symbol to avoid possible injury or death.

This manual contains DANGERS, WARNINGS, CAUTIONS, NOTICES and Notes which must be followed to prevent the possibility of improper service, damage to the equipment, personal injury or death. The following formatting options will apply when calling the readers attention to the DANGERS, WARNINGS, CAUTIONS, NOTICES and Notes.

▲ DANGER

INDICATES A HAZARDOUS SITUATION WHICH, IF NOT AVOIDED, WILL RESULT IN DEATH OR SERIOUS INJURY.

▲ WARNING

Indicates a hazardous situation which, if not avoided, could result in death or serious injury.

▲ CAUTION

Indicates a hazardous situation which, if not avoided, may result in minor or moderate injury.

NOTICE

Indicates a hazardous situation which, if not avoided, may result in property or equipment damage.

Note: Notes contain additional information important to a procedure and will be found within the regular text body of this manual.

OPERATING SAFETY



Before using the pump, be sure you read and understand all of the instructions. This equipment was designed for specific applications; **DO NOT** modify or use this equipment for any application other than which it was designed for. Equipment operated improperly or by untrained personnel can be dangerous. Read the operating instructions and familiarize yourself with the location and proper use of all instruments and controls. Inexperienced operators should receive instruction from someone familiar with the equipment before being allowed to operate or set up the pump. The following points should be practiced at all times:

- The area immediately surrounding the pump should be dry, clean, and free of debris.
- Position and operate the pump on a firm, level surface.
- **NEVER** start a unit in need of repair.
- **NEVER** modify the pump or use it in a manner other than for what it was designed.
- **DO NOT** start the pump if any panels or guards are loose or missing.
- Move the engine start switch to the "OFF" position when servicing or troubleshooting.
- Use hearing protection if you will be near an operating pump for an extended period of time.
- Keep clear of pump suction and discharge openings while pump engine is running.
- Keep all body parts, loose clothing and any other obstructions away from moving parts.
- **NEVER** operate a unit while tired, distracted, or under the influence of drugs or alcohol.

ENGINE SAFETY



Internal combustion engines present special hazards during operation and fueling. Failure to follow the safety guidelines described below could result in severe injury or death. Also read and follow all safety warnings described in the engine operator's manual. A copy of this manual was supplied with the unit when it was shipped from the factory.

- **DO NOT** run engine indoors or in an area with poor ventilation unless exhaust hoses are used. Diesel engine exhaust contains carbon monoxide, a deadly, odorless and colorless gas which, if inhaled, can cause nausea, fainting or death. Make sure engine exhaust cannot seep into closed rooms or ventilation equipment.
- **DO NOT** fill fuel tank near an open flame, while smoking, or while engine is running. **DO NOT** fill tank in an enclosed area with poor ventilation.
- **DO NOT** operate with the fuel tank cap loose or missing.
- **DO NOT** operate on a combustible surface.
- **DO NOT** touch or lean against hot exhaust pipes or engine block.
- **DO NOT** clean air filter with gasoline or other types of low flash point solvents.
- **DO NOT** remove engine coolant cap while engine is hot.
- **DO NOT** operate the unit without a functional exhaust system. Prolonged exposure to sound levels in excess of 85 dB(A) can cause permanent hearing loss. Wear hearing protection when working around a running engine.
- Keep hands, feet and loose clothing away from moving parts on the pump and engine.
- Keep area around exhaust pipes and radiator free of debris to reduce the chance of an accidental fire.
- Batteries contain sulfuric acid, which can cause severe injury or death. Sulfuric acid can cause eye damage, burn flesh or eat holes in clothing. Protective eye wear and clothing are necessary when working on or around the battery. Always disconnect the **negative (-)** battery cable from the corresponding terminal before performing any service on the engine or other components.
- Shut down the engine if any of the following conditions exist during operation:
 1. Noticeable change in engine speed.
 2. Loss of pumping output.
 3. Sparking occurs.
 4. Engine misfires or there is excessive engine or pump vibration or noise.

PUMP SAFETY



Centrifugal pumps are designed for specific applications and may not be suited for other uses without loss of performance or potential damage to equipment/personnel. If there is any doubt about suitability for a specific purpose, contact Magnum Power Products LLC for assistance. Follow the safety guidelines described below to prevent hazardous situations which could result in severe injury or death.

- This pump is designed to handle mild industrial corrosives, residues, and slurries containing some large entrained solids. Do not attempt to pump volatile, corrosive, or flammable materials that may damage the pump or endanger personnel as a result of pump failure.
- After the pump has been positioned, make certain that the pump and all hose/piping connections are tight, properly supported and secure before operation.
- **DO NOT** operate the pump without the guards in place over the rotating parts. Exposed rotating parts can catch clothing, fingers, or tools, causing severe injury to personnel.
- **DO NOT** remove plates, covers, gauges, pipe plugs, or fittings from an overheated pump. Vapor pressure within the pump can cause parts being disengaged to be ejected with great force. Allow the pump to cool before servicing.

- **DO NOT** operate the pump against a closed discharge valve for long periods of time. If operated against a closed discharge valve, pump components will deteriorate, and the liquid could come to a boil, build pressure, and cause the pump casing to rupture or explode.
- Remove suction and discharge hoses/piping from pump prior to moving. Use lifting and moving equipment with adequate capacity and in good repair.
- **NEVER** exceed the maximum permissible operating pressure of the pump as shown on the pump performance curve.
- If equipment is stored more than 12 months, some of the components or lubricants may have exceeded their maximum shelf life. These must be inspected and replaced as necessary prior to pump operation to ensure proper pump performance.

SERVICE SAFETY



All service work must be performed by qualified personnel who are familiar with the equipment. Only a qualified electrician should troubleshoot or repair electrical problems occurring in this equipment. Follow the safety guidelines described below to prevent hazardous situations which could result in severe injury or death.

- Before servicing the trash pump, make sure the Engine Start switch is turned to “OFF” and the negative terminal on the battery is disconnected. **NEVER** perform even routine service (oil/filter changes, cleaning, etc.) unless all electrical components are shut down.
- **NEVER** service electrical components if clothing or skin is wet. If the unit is stored outside, check the engine for any moisture and dry the unit before use.
- **NEVER** open the radiator cap or oil drain plug while the engine is running or before the engine has cooled down. Pressurized coolant and hot engine oil can cause severe burns. Allow the engine and pump to cool completely before attempting any service work.
- Check the temperature before opening any pump covers, plates or plugs. Allow the pump to cool if overheated.
- Before servicing the pump end, close the suction and discharge valves. Vent the pump slowly and cautiously. Drain the pump completely.
- **NEVER** attempt to modify the engine, pump or related components.
- **NEVER** wash the unit with a power washer or high pressure hose.
- Replace all guards and safety devices immediately after servicing.
- Replace all missing and hard-to-read labels. Labels provide important operating instructions and warn of dangers and hazards.
- Make sure slings, chains, hooks, ramps, jacks, and other types of lifting devices are attached securely and have enough weight-bearing capacity to lift or hold the equipment safely. Always remain aware of the position of other people around you when lifting the equipment.

TOWING SAFETY



Towing a trailer requires care. Both the trailer and vehicle must be in good condition and securely fastened to each other to reduce the possibility of an accident. Also, some states require that large trailers be registered and licensed. Contact your local Department of Transportation office to check on license requirements for your particular unit.

- Check that the hitch and coupling on the towing vehicle are rated equal to, or greater than, the trailer's Gross Vehicle Weight Rating (GVWR).
- Check tires on trailer for tread wear, inflation and condition.
- **NEVER** tow trailer using defective parts. Inspect the hitch and coupling for wear or damage.
- Make sure the trailer hitch and the coupling are compatible. Make sure the coupling is securely fastened to the vehicle.

- Connect safety chains in a crossing pattern under the tongue and **ATTACH THE BREAKAWAY CABLE TO THE REAR BUMPER OF THE TOWING VEHICLE.** Do not attach the cable to the trailer hitch.
- Make sure directional and brake lights on the trailer are connected and working properly.
- Check that all lug nuts holding wheels on are tight and that none are missing.
- Maximum recommended speed for highway towing is 45 mph (72 km/h). Recommended off-road towing speed is not to exceed 10 mph (16 km/h) or less, depending on terrain.

The trailer is equipped with hydraulic surge brakes or electric surge brakes. Check the operation of the brakes by braking the vehicle at a slow speed before entering traffic. Both the trailer and the vehicle should brake smoothly. If the trailer seems to be pushing, check the level in the surge brake fluid reservoir.

When towing, maintain extra space between vehicles and avoid soft shoulders, curbs and sudden lane changes. If you have not pulled a trailer before, practice turning, stopping, and backing up in an area away from heavy traffic.

A film of grease on the coupler will extend coupler life and eliminate squeaking. Wipe the coupler clean and apply fresh grease each time the trailer is towed.

REPORTING TRAILER SAFETY DEFECTS

If you believe your trailer has a defect which could cause a crash or could cause injury or death, you should immediately inform the National Highway Traffic Safety Administration (NHTSA) in addition to notifying Magnum Power Products LLC.

If NHTSA receives similar complaints, it may open an investigation; and if it finds that a safety defect exists in a group of vehicles, it may order a recall and remedy campaign. However, NHTSA cannot become involved in individual problems between you, your dealer, or Magnum Power Products LLC.

To contact NHTSA, you may either call the Auto Safety Hotline toll-free at 1-888-327-4236 (TTY:1-800-424-9153), go to <http://www.safercar.gov>; or write to:

Administrator
NHTSA
1200 New Jersey Avenue S.E.
Washington, DC 20590

You can also obtain other information about motor vehicle safety from <http://www.safercar.gov>.



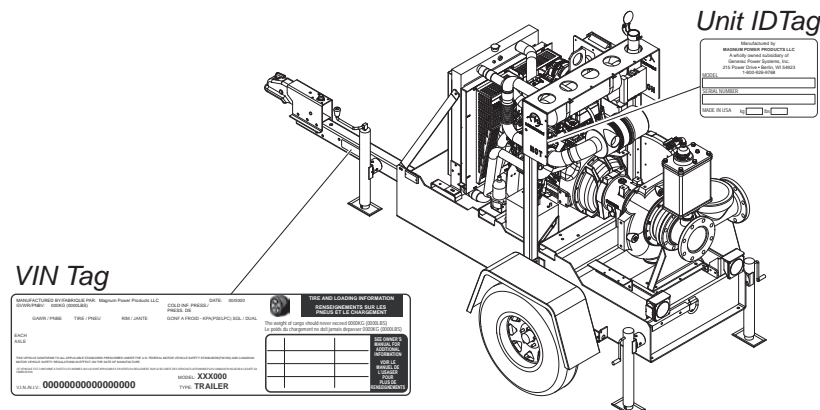

UNIT SERIAL NUMBER LOCATIONS

Refer to the locations illustrated to find the unit ID tag and VIN tag on your unit. Important information, such as the unit serial number, model number and Vehicle Identification Number (VIN) for your trailer are found on these tags. Record the information from these tags so it is available if the tags are lost or damaged. When ordering parts or requesting technical service information, you may be asked to provide this information.



SAFETY SYMBOL SUMMARY

This equipment has been supplied with numerous safety and operating decals. These decals provide important operating instructions and warn of dangers and hazards. Replace any missing or hard-to-read decals and use care when washing or cleaning the unit. Decal placement and part numbers can be found in the parts manual. Below is a summary of the intended meanings for the symbols used on the decals.

 <p>Safety alert symbol; used to alert you to potential personal injury hazards.</p>	 <p>Asphyxiation hazard; operate in well ventilated area.</p>
 <p>Hot surface(s) nearby.</p>	 <p>Hazardous voltage. Disconnect battery before servicing.</p>
 <p>Belt/entanglement hazard; keep body parts clear of this area.</p>	 <p>Anchor/tie down point.</p>
 <p>Rotating fan hazard; do not operate without guards in place. Keep body parts clear of this area.</p>	 <p>Burn/scald hazard; pressurized steam.</p>
 <p>Rotating impeller blade hazard; keep body parts clear of this area.</p>	 <p>Use clean diesel fuel only.</p>
 <p>Moving parts can crush and cut; keep body parts clear of this area.</p>	 <p>Remove negative battery cable before performing any service on unit.</p>
 <p>Stop engine before fueling.</p>	 <p>Read and understand the supplied operating manual before operating unit.</p>
 <p>Hearing protection required while operating unit.</p>	 <p>Lift here only.</p>
 <p>Fire/explosion hazard; keep open flames away from unit.</p>	

SPECIFICATIONS

Read this manual carefully before attempting to use this equipment. The potential for property damage, personal injury or death exists if this equipment is misused or installed incorrectly. Read all of the manuals included with this unit. Each manual details specific information regarding items such as set up, use and service requirements. **SPECIFICATIONS ARE SUBJECT TO CHANGE WITHOUT NOTICE.**

MAGNUM MODEL

MTP6000D3

Engine:

Make/Brand	John Deere
Model	PE4024HF285
Type	Diesel, liquid cooled, 4-stroke
Displacement in³ (L)	149 (2.4)
Cylinders - qty	4
Eng Rated Speed rpm	2800
Eng Pwr @ Rated Speed - Int. hp (kW)	80 (60)
Eng Operating Speed rpm	2200
Eng Pwr @ Oper. Speed - Int. hp (kW)	82 (61.1)
Fuel Consumption - 100% load gph (Lph)	2.11 (7.99)
Battery Type - Group Number	24
Battery Voltage (Quantity per Unit)	12V (1)
Battery Rating	720 CCA
Alternator Rating	70A

Pump:

Make/Brand	Pioneer Pump Inc.
Model	VP66S10L72-EG410
Fitting Size	6" NPTF
Impeller Material	CA6NMStainless Steel
Impeller Diameter in (mm)	10 (254)
Shaft Material	Lasalle Stressproof (modified AISI 1144 stl)
Volute Material	ASTM A536 Ductile Iron
Wear Plate Material	ASTM A536 Ductile Iron

Pump Set (Engine/Pump):

Maximum Diameter of Solids in (mm)	3.0 (76.2)
Maximum Pump Output gpm (Lpm)	3050 (11546)
Maximum Lift Suction ft (m)	28 (8.5)
Maximum Operating Speed rpm	2300
Total Dynamic Head ft (m)	165 (50.29)
Sound dB(a) 23 ft. @ prime	80

Dimensions (LxWxH):

Skid Mounted in (m)	82 x 35 x 60 (2.08 x 0.89 x 1.52)
Trailer Mounted in (m)	138 x 57 x 78 (3.51 x 1.45 x 1.98)

Weights:

Dry Weight, Skid Mounted lbs (kg)	2588 (1174)
Operating Weight, Skid Mounted lbs (kg)	3380 (1533)
Dry Weight, Trailer Mounted lbs (kg)	3138 (1423)
Operating Weight, Trailer Mounted lbs (kg)	3930 (1783)

Capacities:

Fuel Tank Volume gal (L)	110 (416)
Usable Fuel Volume gal (L)	95 (360)
Maximum Run Time hrs	34

Trailer:

Number of Axles	1
Capacity - Axle Rating lbs (kg)	5000 (2268)
Tire Size in	15
Brakes	Surge
Hitch - Standard	2" Ball
Maximum Tire Pressure psi	65

COMPONENT LOCATIONS

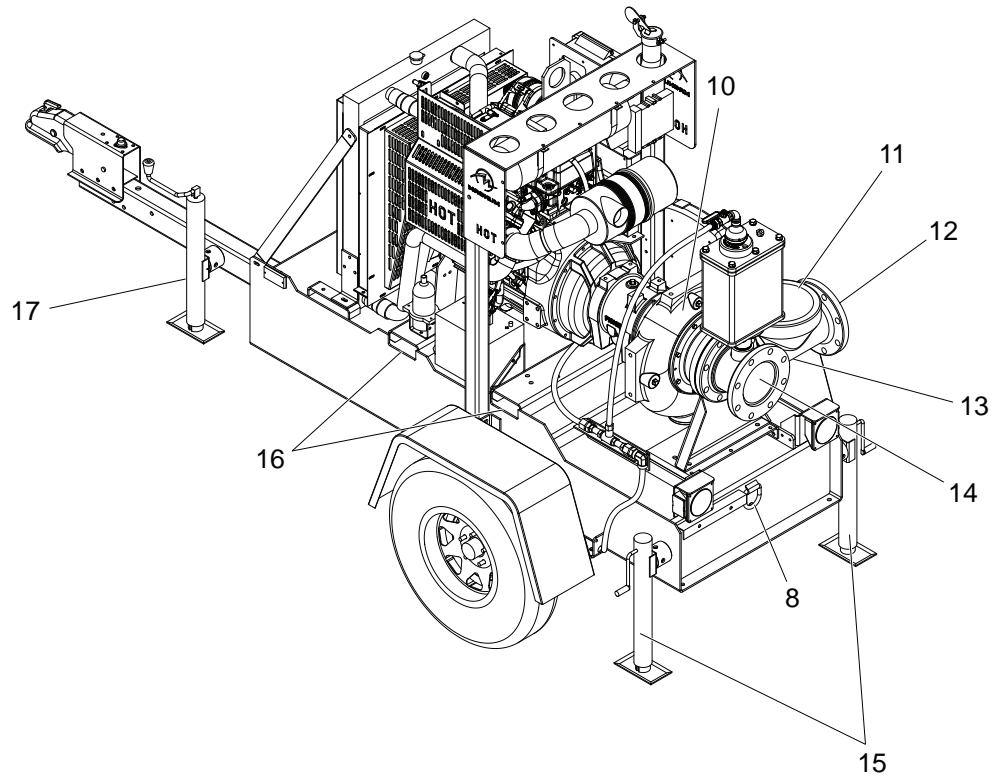
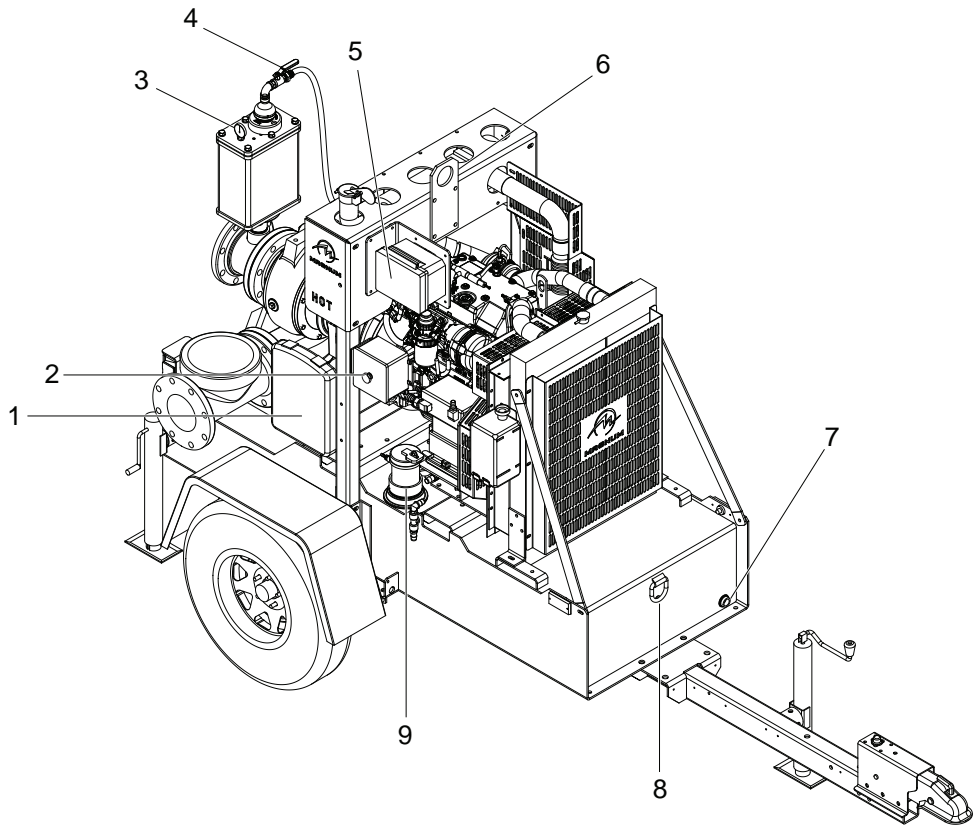

1. **MANUAL HOLDER:** Storage for operator manuals.
2. **EMERGENCY STOP:** Activate the “EMERGENCY STOP” switch by pushing the red button in until it locks down. Only use when the pump must be shut down immediately. For any other shut down, follow the procedure on [page 31](#).
3. **VACUUM GAUGE:** Used to determine if the pump is achieving prime. After engine shutdown, this gauge is used to determine if the pump is holding prime. Typical range is 20-25 in/Hg.
4. **FLOODED SUCTION BYPASS VALVE:** This valve is used to prevent water from back-flowing into the compressor when there is a flooded suction. The valve should remain open for normal pump operation. (Pictured in open position.)
5. **CONTROL PANEL:** Controls and indicators for pump operation.
6. **CENTRAL LIFT POINT:** Used for lifting the pump.
7. **FUEL TANK DRAIN:** Drain for fuel tank for cleaning and/or maintenance.
8. **TIE-DOWN RINGS:** Used to secure the pump for storage and/or transport.
9. **FUEL FILL PORT:** Lockable port for filling the fuel tank with clean **DIESEL** fuel.
10. **PUMP VOLUTE (HOUSING):** Cast iron housing for pump mechanical components.
11. **CHECK VALVE:** A valve that permits flow in one direction only. (Required for pump priming.)
12. **PUMP OUTLET (DISCHARGE) PORT:** Opening for discharge of liquids from the pump. Fittings can be threaded or bolted to the pump flange.
13. **DRAIN/SUCTION HOSE RELEASE VALVE:** Allows for complete draining of the pump volute for storage and/or maintenance. This valve can also be opened to relieve pressure on the rear suction hose to facilitate removal of the hose.
14. **PUMP INLET (SUCTION) PORT:** Opening for intake of liquids into the pump. Fittings can be threaded or bolted to the pump flange.
15. **REAR LEVELING JACKS:** Used to level the rear of the pump on rough or uneven ground.
16. **FORK LIFT POCKETS:** Used for lifting the pump.
17. **FRONT LEVELING JACK:** Used to level the pump on rough or uneven ground and to aid in attaching the pump to a tow vehicle.

Note: Use hoses and fittings that are specifically designed and sized for this type of equipment.

CONTROL PANEL

The CANplus® 600 (CP600™) control panel is an economical platform to monitor and control electronically governed diesel engines. Graphical gauge pages or a single large analog gauge are displayed on the 4.25 in (107.95 mm) diagonal LCD. Virtually any SAE J1939 parameter reported by the ECU (Engine Control Unit) can be displayed including RPM, coolant temperature, oil pressure, engine hours, voltage and diagnostic codes. The trans-reflective, backlit display is clearly readable in both bright sunlight as well as total darkness and is housed in a rugged IP67 rated housing.

Current alarm conditions are displayed in plain language on popup messages and can be viewed in the alarm list. Various diagnostic screens allow detailed investigation of the CANbus data stream. By accessing the “Configuration” menu, users can customize displayed data to show metric or US units, display language and various other parameters such as the full-scale reading of gauges.

Five buttons access a context dependent button bar when any button from 1 to 4 is pressed. The graphical menu structure uses easily understood icons to indicate the button’s current function. After five seconds of inactivity, the button bar disappears.



Button 1	Button 2	Button 3	Button 4	Button 5
<p>Analog Gauge Pages</p> <p>Repeated presses cycle through four pages of analog gauges (16 total)</p>	<p>Digital Gauge Pages</p> <p>Repeated presses cycle through four pages of digital gauges (16 total)</p>	<p>Single Analog Gauge</p> <p>Repeated presses cycle through available analog gauges.</p>	<p>Active Alarm Page</p> <p>Displays active alarms including a plain language description.</p>	<p>Gauge Adjust</p> <p>Configures the parameters displayed by gauge pages.</p> <p>(Quad Adjust must be enabled.)</p>

Note: Most problems with electronically controlled engines can be pinpointed via ECU diagnostic messages. Use the display or ECU diagnostic tool to view fault codes. Engine state information and diagnostic codes displayed by the CANplus display are provided via the CANbus.

THROTTLE CONTROL

The standard ramp throttle uses a momentary rocker switch to adjust the integral throttle control. All throttle commands are sent directly to the engine using CANbus throttle control.

SERVICE TIMERS

The CP600™ display provides 16 service timers to alert the operator of needed maintenance. The time interval for each timer can be adjusted in 10 hour increments. A popup message is displayed after the display self test if a timer has expired, alerting the user that service is required. The message is displayed on each power up until the elapsed timer is disabled or reset.

CANPLUS MESSENGER TELEMETRY OPTION

The optional CANplus Messenger system provides a variety of features to protect and support the equipment investment. Remote monitoring can alert maintenance requirements, operational problems, improper operation and location with geo-fence alert. The Web-browser interface allows monitoring an entire fleet of equipment in a central location. Contact Magnum Power Products LLC for more information.

CONTROL PANEL OPERATION

Turning the control system key to the “RUN” position energizes the ECU and a start-up screen is displayed while a self test is performed. If the display beeps for longer than one second, it indicates a self test fault. Users can attempt to rectify the fault by restoring factory defaults (see [“Configuration Menu” on page 16](#) for details). Contact Magnum Power Products LLC for assistance if the fault persists.

After the start-up screen is cleared, the display shows readings on its virtual gauges. Initially the analog gauges are displayed but the display uses the last displayed screen on subsequent startups (see [“Preferred Screen Store” on page 24](#) for details).

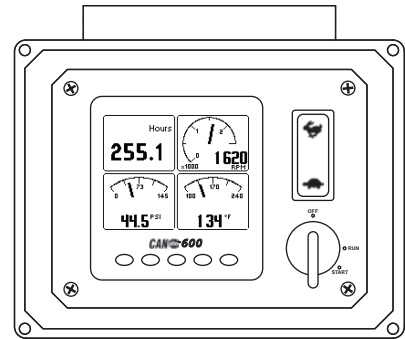

If the ECU is preheating when the key switch is turned to the “RUN” position, a Preheat screen will appear. Preheat time varies with atmospheric and engine conditions. After waiting for the Preheat screen to extinguish, the engine is cranked by turning and holding the key switch in the “START” position until the engine starts.

Note: *The ECU will not preheat unless conditions warrant. If necessary, starting the engine may be attempted by turning the key to the “START” position without waiting for preheat to expire. The key switch is spring loaded to return automatically to the “RUN” position when released. The key switch includes an interlock to prevent the key from being turned to the “START” position while the engine is running. The key switch must be turned to the “OFF” position to reset the starter interlock before the switch can be turned to the “START” position again.*

THROTTLE CONTROL

The type of throttle operators installed along with the configured values of minimum requested RPM, idle RPM, intermediate RPM, run RPM and maximum requested RPM determine throttle operation. The engine speed can be adjusted above run RPM and below idle RPM but the requests can not fall below the set minimum requested RPM or above the set maximum requested RPM. The ECU determines how the engine responds to the throttle requests and will not allow the engine speed to fall below the ECU minimum or exceed the maximum RPM.

Note: *To change the minimum requested RPM and maximum requested RPM settings, contact Magnum Power Products LLC.*

RAMP THROTTLE (SPEED CONTROL SWITCH)

The standard ramp throttle uses a momentary rocker switch to adjust the requested engine speed. When first started, the requested engine speed is “Idle RPM”. Pressing and releasing the Rabbit 🐰 icon increases the speed requested by 25 RPM. Pressing and holding the Rabbit icon causes the speed to accelerate to full speed in a few seconds. Similarly, pressing the Turtle 🐢 icon decreases the requested speed.

CANPLUS DISPLAY

Soft buttons simplify the user interface by displaying a button bar above the buttons when any of the first four buttons (buttons 1 to 4, starting from the left) are pressed. Icons on the button bar change to represent the current function of each button. The button bar disappears after five seconds if no further buttons are pressed.

Note: Different software versions may have slightly different displays.

ANALOG GAUGE PAGES



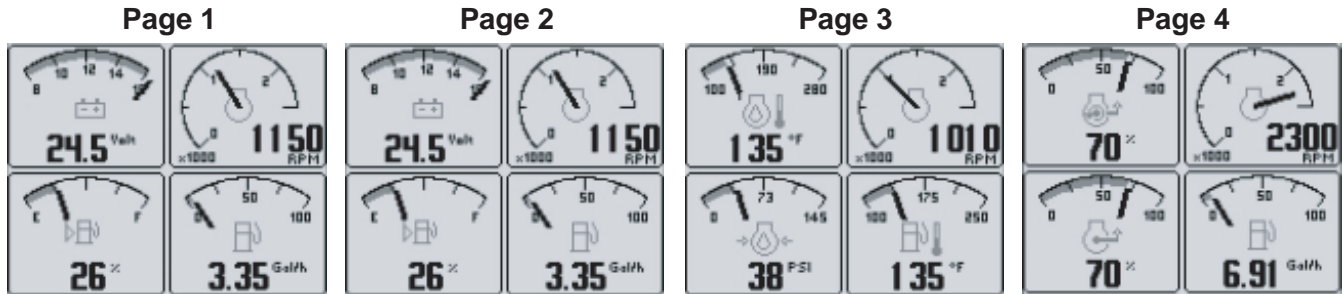

Analog Gauge Pages provide four independent pages of analog gauges. To enable Analog Gauge Pages, press any of the first four buttons to show the top level button bar and then press button 1 . Alternate pages are selected by repeated pressing of button 1. The four standard gauge pages are shown below.



Note: Engine hours are displayed as a digital value even on Analog Gauge Pages. The default gauge pages represent 13 selections since the tachometer is repeated in the upper right quadrant of each page.

All 16 gauges may be configured by the user to create an application-specific view of CANbus data. Gauges on the current page can be changed via Adjust mode, accessed by pressing button 5  when the button bar is visible. Gauges can be changed on any of the four pages by selecting the page to be changed and then entering Adjust mode.

Note: “Quad Adjust” must be enabled to access the Adjust mode.

In Adjust mode a new button bar is displayed identifying the button functions. Button 1  corresponds to the upper left gauge, button 2  to the upper right gauge, button 3  to the bottom left gauge and button 4  to the bottom right gauge. Successive presses of the buttons selects a different parameter for the gauge. Adjust mode is exited by pressing button 5  and storing the new configuration even when power is removed.

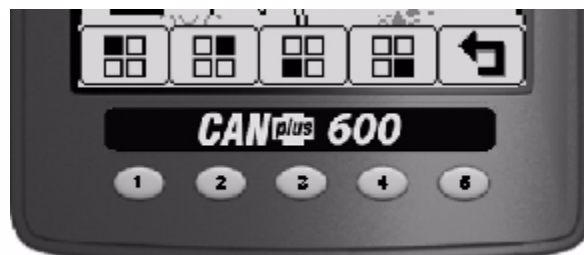

Note: A gauge selection can only appear once per page. To move a gauge selection, the existing gauge location must be changed first. Gauge selections are limited to the data currently being received. Gauge pages can be configured in Demo mode to select any supported parameter. See Data Parameters Monitored for a complete list of available parameters.

Adjust mode can be disabled in the “Configuration” menu (“Quad Adjust - Off”) to prevent accidental changes.

DIGITAL GAUGE PAGES

Digital Gauge Pages display the same data as the Analog Gauge Pages but in digital only format. To enable Digital Gauge Pages, press any of the first four buttons to show the top level button bar and then press button 2 . Alternate pages are selected by repeated pressing of button 2. The four standard gauge pages are shown below.

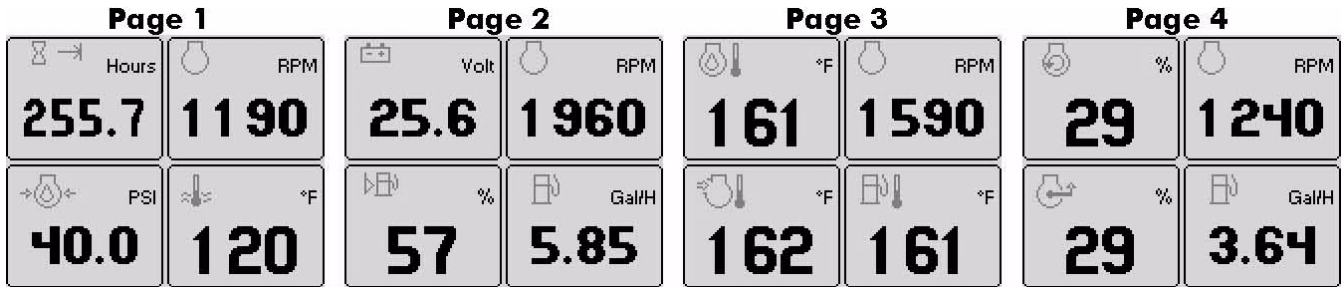

Note: The 16 gauges are the same for Analog and Digital Gauge Pages. Adjustments in either Analog Gauge Pages or Digital Gauge Pages affect the same gauge in the other mode.

SINGLE ANALOG GAUGE

Single Analog Gauge uses the entire display for a single large analog gauge. This mode is enabled by pressing any of the first four buttons to show the top level button bar and then press button 3. The gauge displayed is selectable by repeatedly pressing button 3  while in the Single Analog Gauge mode while the menu bar is visible. The currently displayed gauge is stored when power is removed (see Preferred Screen Store).

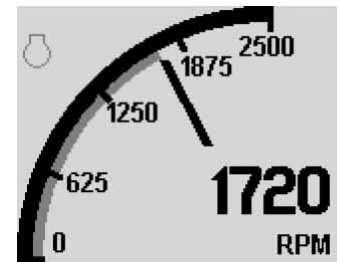

Note: Gauge selections are limited to the data currently being received. See Data Parameters Monitored for a complete list of available parameters.

ACTIVE ALARMS



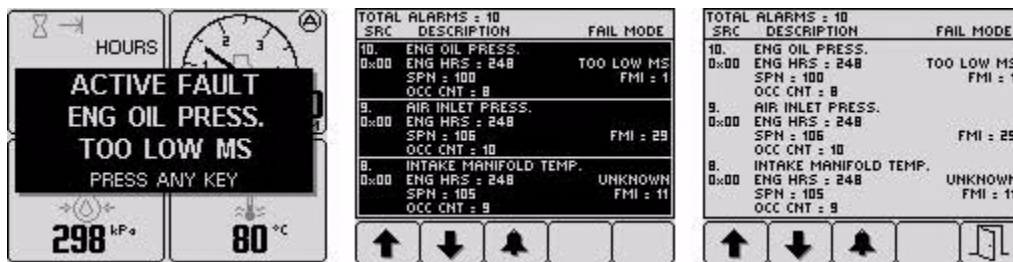

A flashing popup window is overlaid on the current screen when an active alarm is received. The popup includes a plain language description in addition to the standard SPN/FMI (Suspect Parameter Number/Failure Mode Indicator) pair defined by the SAE J1939 standard. Additionally, if enabled, the beeper sounds as an audible cue.



Example alarm message, alarm list screens showing unacknowledged conditions and acknowledged alarms. After acknowledgement, the Exit button  becomes active.

Note: Standard J1939 abbreviations are used for alarms. MS = Most Severe, MOD = Moderately Severe, LS = Least Severe.

ALARM LIST

The Alarm List is accessed by pressing any button while an alarm popup is displayed or by pressing any of the first four buttons to show the button bar and then button 4 . Alarms not yet acknowledged are shown in grey on black while acknowledged alarms are shown in black on grey. The list also indicates when the alarm occurred if engine hours are available. The most recent alarm is displayed at the top of the list. The list can be scrolled using buttons 1  and 2  and alarms acknowledged by pressing button 3 . The Alarm List can be closed by pressing button 5  once the alarms are acknowledged.





An Alarm indicator  is displayed near the upper right corner of the display as long as alarms are active. The indicator and alarm messages in the list are automatically removed when the alarm is no longer received for a few seconds.

Note: Only active faults are displayed in the alarm list. Once a fault is corrected, it is automatically removed from the list. To view previously active faults, use the engine diagnostic tool.

CONFIGURATION

To adapt the CP600™ panel to the requirements of a particular application, a large number of parameters are configurable. The most commonly modified parameters can be accessed by invoking the “Configuration” menu of the display. Infrequently changed parameters and those parameters that typically need to be restricted such as Maximum RPM are accessible only through the CANplus Configurator. The CANplus Configurator is a Windows® PC program and a hardware adapter that allows total access to the parameters of the panel. For more information about the CANplus Configurator, please contact Magnum Power Products LLC.

CONFIGURATION MENU

This “Configuration” menu allows the user to set various operating parameters such as US or metric units, scale limits for tachometer and service timers. The “Configuration” menu is entered by pressing and holding button 5 (the right hand button) in any mode for at least three seconds. If PIN (Personal Identification Number or ‘password’) entry is enabled, the correct PIN must be entered to access the “Configuration” menu. The top level configuration menu is displayed as shown. Buttons 1  and 2  allow you to choose from “Display”, “System”, “Throttling”, “Telemetry” or “Db Viewer”. Pressing button 4  selects the chosen menu item indicated by bold text and the Selection Arrow . Each item is described in detail on the following pages. Settings are automatically stored when exiting the current menu even when power is removed.

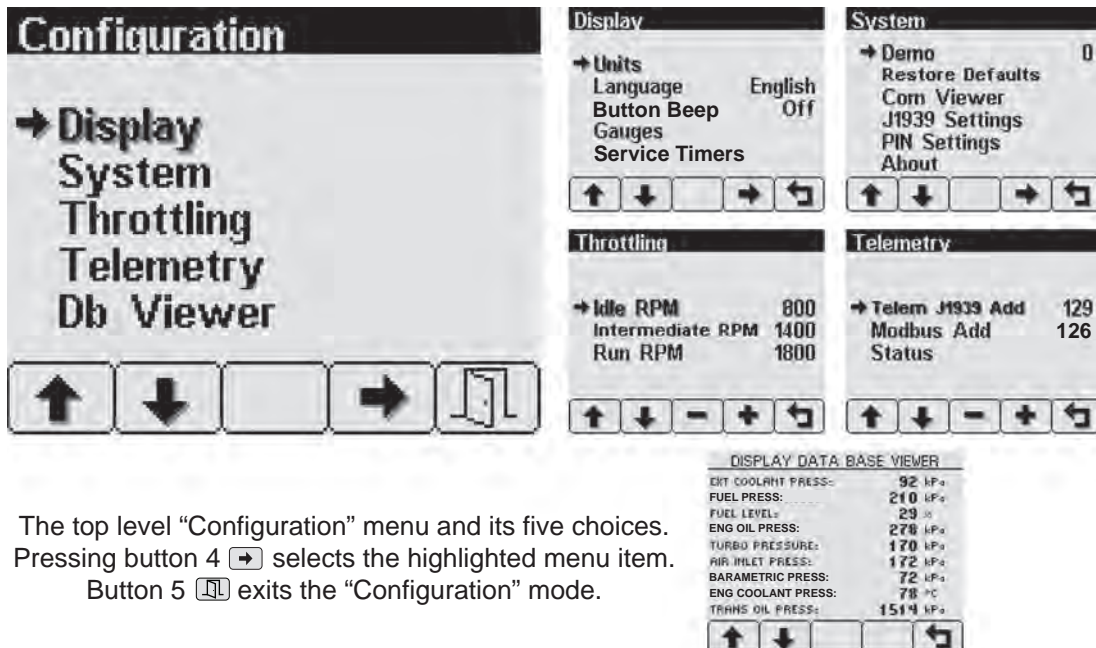

Note: Most configuration changes take effect immediately. Some such as Idle RPM take effect on the next power up.

DISPLAY MENU

The “Display” menu allows the user to configure items affecting how information is displayed.

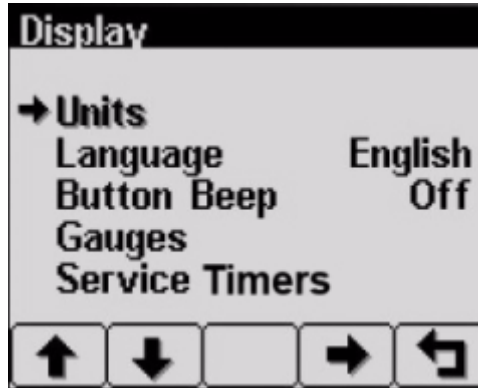

UNITS MENU

This menu allows the user to set the units used for speed, distance, pressure, volume and temperature independently. Button 4 cycles through the available values for the selected item.

- Speed** MPH (miles per hour); km/h (kilometers per hour); Knts (knots)
- Distance** Miles; km (kilometers); NM (nautical miles)
- Pressure** PSI (pounds per square inch); bar (barometric units); kPa (kilopascals)
- Volume** Gal (US gallons); lGal (Imperial gallons); Liters
- Temperature** °F (Fahrenheit); °C (Celsius)

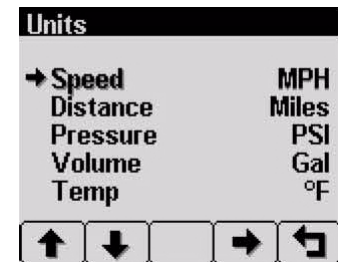

LANGUAGE MENU

This menu allows the user to choose between English, Swedish, French, German, Spanish, Italian, Dutch and Portuguese. The currently selected value is indicated by the Check Mark . Button 4 selects the highlighted value.

BUTTON BEEP

The soft buttons emit an audible beep when this item is “On”. Button beep is disabled by setting this item to “Off”. The audible beep still sounds when an alarm occurs. Button 4 cycles between “On” and “Off”.



GAUGES MENU

This menu allows the user to configure aspects of the gauges displayed. Button 3 selects the previous value while button 4 selects the next value of the highlighted item.

MAX RPM

Sets the full scale RPM indicated by the tachometer gauge.

RPM 2500, 3000, 3500, 4000, 4500, 5000, 6000, 7000, 8000 or 9000

MAX SPEED



Sets the full scale speed indicated by the speedometer gauge.

MPH 15, 20, 25, 30, 35, 40, 45, 50, 55, 60, 70, 75, 80, 85, 95 or 100

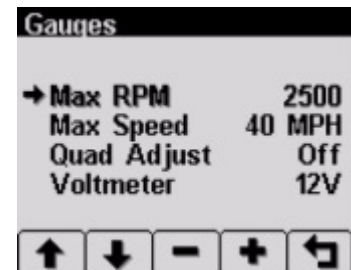
km/h 20, 30, 40, 50, 60, 70, 80, 90, 100, 110, 120, 130, 140, 150 or 160



QUAD ADJUST

Allows the user to disable Adjust mode of the Analog and Digital Gauge Pages. Button 3  disables while button 4  enables Quad Adjust.

Disabling Adjust mode locks the current gauge configuration and prevents the operator from accidentally changing the gauge configuration.



VOLTMETER

Leave at factory default setting (12V).

SERVICE TIMERS

Sets the 16 service intervals in hours and resets the service timer. Setting the service interval to 0 disables the timer and the word "Off" is displayed.

Pressing button 4  allows adjusting the selected service timer.

Button 1  decreases the service interval time while button 2  increases the service interval time in 10 hour increments. Holding button 3  for approximately three seconds resets "Next Service In" to the current service interval. The service timer descriptions can be changed using the CANplus Configurator.

Note: It is not possible to set the service timers if engine hours are not being received by the display.

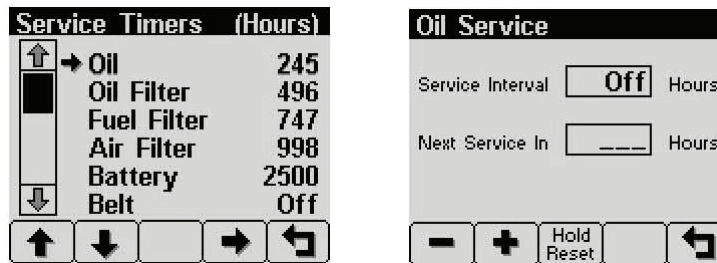

SYSTEM MENU

The "System" menu allows the user to configure items affecting how the system functions. Button 4  cycles through the available values for the selected item.

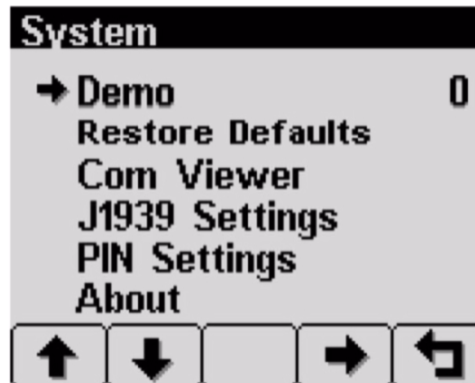

DEMO

The display supports several "Demo" modes to operate with simulated data. Mode 1 simulates speed data and engine parameters. Mode 2 only simulates engine parameters. Mode 3 simulates speed data, engine parameters and alarms. Mode 0 disables "Demo" mode. "Demo" is automatically set to 0 (Off) if live data is received.

RESTORE DEFAULTS

This allows resetting of all configuration information to default US or Metric units. Additionally, the display is reset to the initial configuration.

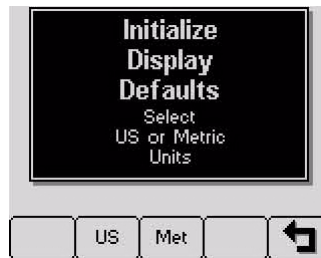

The default settings are:

Setting	US	Metric
Language	English	
Button Beep	On	
Service Timers	Off	
Display Mode	Analog Gauges	
Gauge Pages	Defaults	
Quad Adjust	On	
Demo Mode	0 (Off)	
Engine Source	0	
Display CAN Address	40	
Alarm Filter	Glb	
SPN Version	1	
Speed Source	Auto	
PIN Entry	Off	
PIN	1111	
Max Gauge RPM	2500	
Max Gauge Speed	40 MPH	60 km/h
Speed Units	MPH	km/h
Distance Units	Miles	km
Pressure Units	PSI	kPa
Volume Units	Gal	l
Temperature Units	°F	°C

COM VIEWER



Displays CANbus data received and engine configuration transmitted by the ECU.



J1939 VIEWER

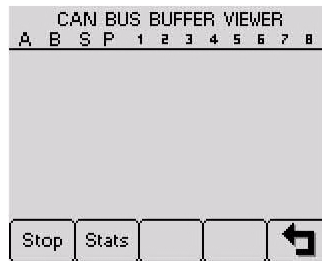

This screen provides a hexadecimal dump of the messages received on the CANbus. This viewer displays the raw data. To see the decoded data, use the “Db Viewer”.

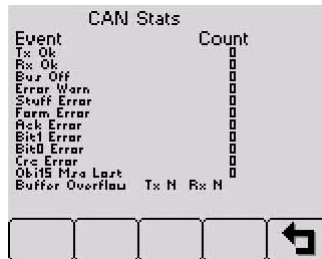

Button 1  freezes the display while button 2  shows CANbus data statistics screen.



ENGINE CONFIG

This screen displays the engine configuration information received from the ECU. Button 2  selects the next page of engine configuration while button 1  selects the previous page.

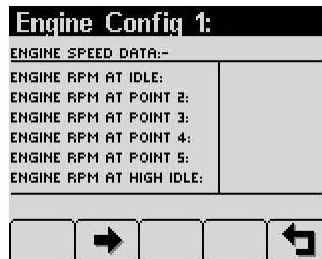

J1939 SETTINGS

This screen allows adjustments specific to the J1939 data link.

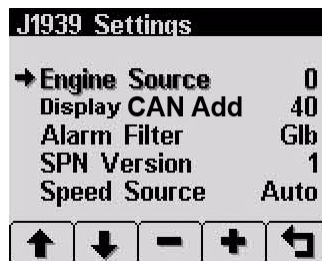

ENGINE SOURCE

Selects which source the display listens to for gauge data. Every device on a J1939 network has a unique address (in the range 0-254) to which the display can choose to listen. The display listens to a single data source; usually the ECU at address 0.

Note: Incorrectly configuring the “Engine Source” address will result in no data available for display.

DISPLAY CAN ADD

As mentioned previously, every device has a unique address and the display is no different. The default display address is 40, the recommended address for single engine setups.

Note: *Incorrectly configuring the display address can result in data collisions on the CANbus.*

ALARM FILTER

This setting specifies whether the display will display alarms from all sources (*Glb* or global) or only the source address specified in the “Engine Source” setting (*Src* or source).

SPN VERSION

Selects the default SPN (Suspect Parameter Number) conversion method version to 1, 2 or 3. Version 4 is automatically detected, but older engines that use conversion method 1, 2 or 3 requires setting this parameter correctly.

Note: *Consult your engine supplier to establish the appropriate SPN conversion method version. Selecting the wrong version will cause alarm data to be displayed incorrectly.*

SPEED SOURCE

There are 3 sources of speed data the display can decode. The settings for this parameter are “Auto”, “NMEA”, “Wheel”, “Nav” and “Off”. “Auto” prioritizes the sources (highest to lowest); “NMEA”, “Wheel” (PGN 65265), Nav (PGN 65272). The selection can be forced to one of the available sources by selecting it explicitly. Selecting “Off” stops the display listening to any source of speed data.





PIN SETTINGS

By default, PIN security is disabled. The user is prompted to enter a PIN every time the “Configuration” menu is accessed after this feature is enabled. To enable the “PIN Entry” feature, you must contact Magnum Power Products LLC to obtain the default pin number.

PIN ENTRY

This allows turning “PIN Entry” on or off. To enable the “PIN Entry” feature, select “PIN Settings” and press button 4 to enable. The default pin number must be entered as a security feature (contact Magnum Power Products LLC). Once the PIN has been entered, the feature is enabled. “PIN Entry” is disabled by setting “PIN Entry” to “Off”.

The digits of the PIN are entered by using the buttons corresponding to the digits of the PIN.

Button 1  adjusts the first digit of the PIN. Button 2  adjusts the second digit, button 3  the third digit and button 4  the fourth digit. The PIN is entered using button 5 .

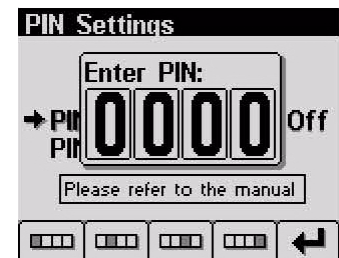
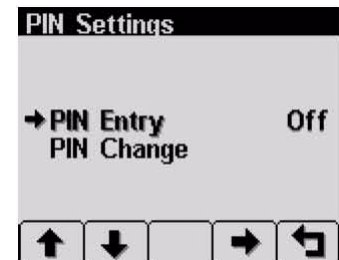

PIN CHANGE

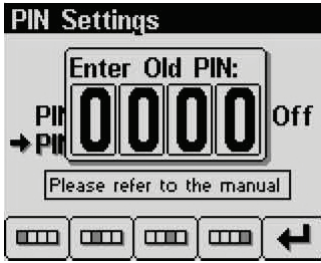

This allows changing the PIN. The user is prompted for the current PIN.

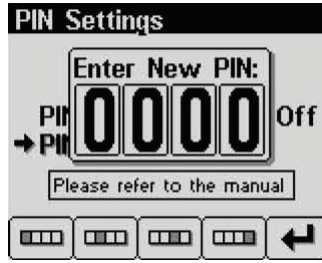

The user is prompted for the new PIN.

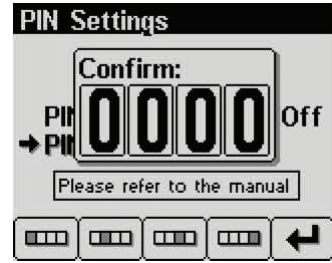

The new PIN must be confirmed before the PIN is changed.

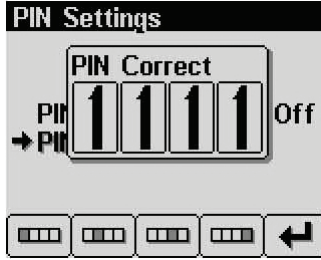

If the new PINs match, a confirmation screen is displayed.

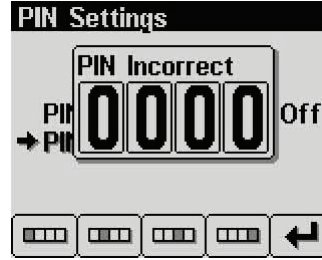

If the two PINs do not match, an error message is displayed and the PIN is unchanged.

⚠ WARNING

If the PIN is changed from the default and the new PIN is lost, the configuration mode will not be accessible. Clearing the PIN requires returning the display to LOFA Industries Inc. for service. Contact LOFA Industries Inc. at 770-569-9828.

ABOUT

Displays the following product information:

JOB	N/A
CONFIG	Magnum programmed controller part number
ADAPTER	Last adapter serial number used to program the controller
VERS	Software version number
PRODUCT	Controller model name
RUN TIME	Hours the unit has been run



THROTTLING MENU

The “Throttling” menu allows the user to configure throttle control.



The “Throttling” menu allows programming the automatic start/stop throttle profiles.

IDLE RPM

Selects the RPM the control system will request for idle speed. Idle can be set to compensate for parasitic loads such as hydraulic pumps or compressors. “Idle RPM” is the low speed setting of the optional two state or three state throttle switches.

Note: *The minimum engine speed is set by the ECU. Requesting a lower speed causes the engine to run at the ECU minimum speed. RPM limits are programmed into the panel to limit the requested speed. Contact Magnum Power Products LLC for information on changing the panel minimum requested RPM and maximum requested RPM.*

INTERMEDIATE RPM

Selects the RPM the control system will request for intermediate speed.

Note: *“Intermediate RPM” is the middle setting of optional three state throttle switches.*

RUN RPM

Selects the RPM the control system will request for run speed.

Note: *“Run RPM” is the high speed setting of the optional two state or three state throttle switches.*

TELEMETRY MENU

This menu allows configuring the optional telemetry system.

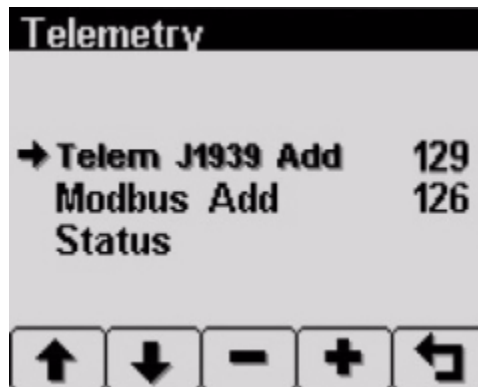

TELEM J1939 ADDRESS

Defines the address the telemetry module is using for CANbus communications.

Note: *The display will be unable to communicate with the telemetry module if this address is incorrect.*

MODBUS ADDRESS

Selects the Modbus slave address the telemetry module will use for Modbus communications.

STATUS

Displays telemetry and modem status information retrieved from the telemetry module:

MODEM TYPE	Identifies the modem type
CELL REG	Identifies cell modem registration
CELL STATE	Indicates cell state and signal strength
GPS	Indicates GPS status
RTC	Indicates number of days since real time clock cellular update
MODBUS SSLT	Indicates Modbus slave status
HDW STATUS	Indicates various hardware status items
SOFTWARE VER	Indicates the version of software in the Messenger

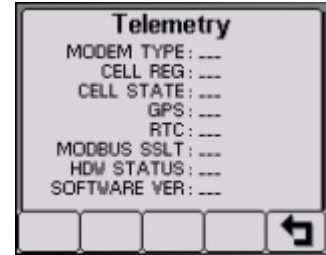

DB VIEWER

The "Database Viewer" displays and decodes all data monitored by the display. This diagnostic tool allows viewing data not normally displayed.

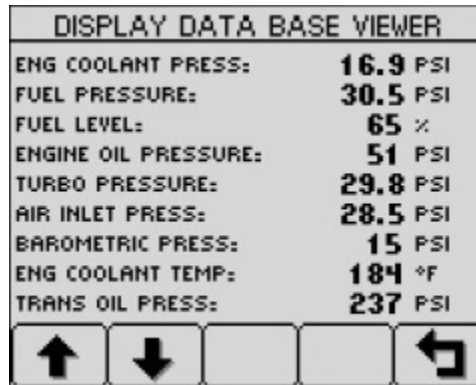

The list can be scrolled using buttons 1  and 2  and closed by pressing button 5 .

Note: The "Database Viewer" is always in English regardless of language selected.

PREFERRED SCREEN STORE

The display automatically stores the current screen as the preferred screen after a delay of approximately 15 seconds. The display will use the last stored screen on the next power-up.

Note: Selecting "Restore Defaults" restores the Analog Gauge Pages and default gauges.

POPUP MESSAGES AND ALERTS

SERVICE REQUIRED

Users can set up to sixteen service timers in hours in the "Configuration" menu. The "SERVICE REQUIRED" popup is displayed at power up when one or more service timers has expired. Pressing any button removes the popup. If no button is pressed, the popup closes in approximately five seconds.

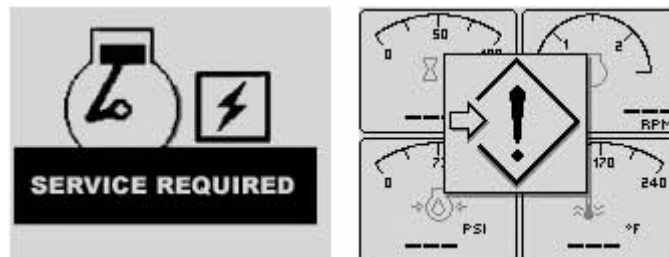

Pop-up warnings of service required and data communications failure.

DATA COMMUNICATIONS FAILURE



The data communications failure popup icon flashes if the display does not detect data. The warning disappears and normal operation resumes once data is detected.

Note: *Incorrectly configuring the “Engine Source” address will result in no data available for display.*

DATA NOT AVAILABLE

Gauges and the “Db Viewer” will display if the desired data is not available. The display value returns to normal when parameter data is received.

ADJUSTING LIGHTING AND CONTRAST

Pressing button 5 (the right-hand button) when there is no menu bar opens the lighting and contrast menu bar. The display has a number of backlighting levels, allowing the display to be read in the dark. The level is adjusted by pressing button 1 (decrease) or button 2 to (increase)  illumination. Contrast is adjusted in the same manner using buttons 3 and 4 .

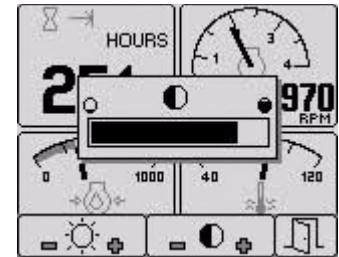







Note: *The display adjusts the contrast with ambient temperature. Manual contrast adjustments are only necessary with extreme climate change.*





























The menu is exited by pressing button 5 . The lighting and contrast settings are retained after the unit is powered off.







Note: *If the contrast has been adjusted poorly, the factory setting is restored by pressing buttons 1 thru 4 simultaneously. This action does not change other user-configured settings.*

DATA PARAMETERS MONITORED

This table lists the engine and transmission parameters that are monitored via the CANbus. The parameters can be displayed by the user-configurable gauge pages or the single analog gauge. DB is an abbreviation for the internal database which stores all data transmitted from the engine/transmission. The complete database can be accessed on the display via the “Db Viewer” in the “Configuration” menu.

Icon	Parameter	Gauge Pages	Single Gauge	Database
	Electrical Potential	●	●	●
	Battery Voltage, Switched	●	●	●
	Net Battery Current	●		●
Fuel (L, Gal, lGal) or (L/h, Gal/h lGal/h) or km/L, MPG or IMPG)				
	Fuel Level	●	●	●
	Fuel Rate	●	●	●
	Instantaneous Fuel Economy	●		●
	Total Fuel Used			●
	Fuel Leakage 1			●
	Fuel Leakage 2			●
Pressure (kPa, PSI or bar)				
	Fuel Pressure	●		●

Icon	Parameter	Gauge Pages	Single Gauge	Database
	Barometer Pressure	●		●
	Auxiliary Pressure 1	●		●
	Turbo Pressure	●	●	●
	Air Inlet Pressure	●		●
	Air Filter Differential Pressure	●		●
	Injector Metering Rail 1 Pressure	●		●
	Injector Metering Rail 2 Pressure	●		●
	Engine Coolant Pressure	●		●
	Engine Oil Pressure	●	●	●
	Injector Control Pressure	●	●	●
Temperature (°C, °F)				
	Engine Coolant Temperature	●	●	●
	Engine Intercooler Temperature	●		●
	Engine Oil Temperature	●	●	●
	Turbo Oil Temperature	●		●
	Intake Manifold Temperature	●	●	●
	Air Inlet Temperature	●	●	●
	Exhaust Temperature	●	●	●
	Auxiliary Temperature 1	●	●	●
	Engine ECU Temperature			●
	Exhaust Gas Port 1 Temperature	●		●
	Exhaust Gas Port 2 Temperature	●		●
	Turbo Inlet Temperature	●		●
Percentage (%)				
	Engine Oil Level	●	●	●
	Coolant Level	●	●	●
	Fan Speed	●		●
	Drivers Demand Percent Torque	●		●
	Actual Engine Percent Torque	●	●	●
	Percent Load at RPM	●	●	●
Speed (RPM, km/h, MPH or KTS)				
	Input Shaft Speed	●		●

Icon	Parameter	Gauge Pages	Single Gauge	Database
	Output Shaft Speed	●		●
	Engine Speed	●	●	●
	Turbo 1 Speed	●		●
	Engine Desired Operating Speed	●		●
Time (h)				
	Total Engine Hours	●		●
	Trip Engine Hours	●		●
	Service Hours			●
Miscellaneous				
	CANTX Disable			●

ENGINE BREAK-IN REQUIREMENTS

Note: During the first 20 hours of operation, avoid long periods of low engine speed or sustained maximum engine speed.

John Deere engines are supplied with engine break-in oil from the factory. Extra care during the first 100 hours of engine operation will result in better performance and longer engine life. **DO NOT** exceed 100 hours of operation with the break-in oil. Operate the engine at high engine speeds (60-90% of maximum) as much as possible. If the engine has spent significant time at idle, constant speed(s) and/or light load, or if makeup oil is required, a longer break-in period may be needed. Consult the engine operator's manual for a full description of necessary procedures on the addition of break-in oil and extension of the break-in period. Use the schedule table on [page 33](#) as a guide for regular maintenance intervals.

PUMP PRE-USE CHECKPOINTS

Before using the pump, be sure to check the following:

- Place the pump as close as possible to the liquid being pumped, keeping the number of hose sections and couplings to a minimum. The pump should be the highest point between the intake and outlet section of the suction hoses.
- Make sure the ground is firm and as level as possible. Block the wheels on the trailer to keep it from moving.
- Check the pump discharge area; make sure discharge will not erode the material under the pump or damage any nearby structures.
- Make sure all hose couplings are of the same size and type.
- All hoses/piping should be supported, braced and lined up square before connection to the pump flanges. A flexible fitting is recommended on both suction and discharge to eliminate misalignment loads or stresses being transmitted to the pump.

Note: Flexible pipe couplings must be restrained so as not to transmit any strain to the pump flanges when expanding or contracting under pressure. Unrestrained expansion fittings can transmit enormous forces to the pump flanges.

▲ WARNING

The pump is designed to handle water and/or other liquids containing some slurries and other entrained solids up to a certain diameter (see “Specifications” on page 9 for the correct diameter). It MUST NOT be used to pump volatile, corrosive or flammable materials that may damage the pump, cause pump failure, or result in explosion. Serious personal injury could result.

PUMP SET UP

1. Disconnect the pump from the tow vehicle by turning the tongue jack clockwise to raise the tongue from the hitch. Disconnect all safety chains, surge brake cables and the trailer wiring harness.
2. Lower the rear leveling jacks from the travel position. Turn the jack handles clockwise until the leveling feet are in firm contact with the ground. Adjust the jacks until the pump is as level as possible.
3. Attach fittings to both the intake and outlet openings of the pump, making sure they match the fittings on the hoses. Threaded fittings require the use of pipe thread sealant. Make sure a gasket/seal is in place between the pump volute and the flange on the fitting being attached. Tighten all hardware completely to ensure an airtight seal.
4. Attach a rigid hose or pipe to the intake (suction) side of the pump. To prevent cavitation, the suction hose/piping should be at least as large as the pump flange, never smaller. The pump should be at the highest point of the hose/piping. All suction piping and fittings should be checked for any foreign material (rocks, bolts, wire, etc.) and also any sharp burrs that could disrupt the flow. Make sure the O-ring seal is present in the fitting on the pump before attaching the fitting.

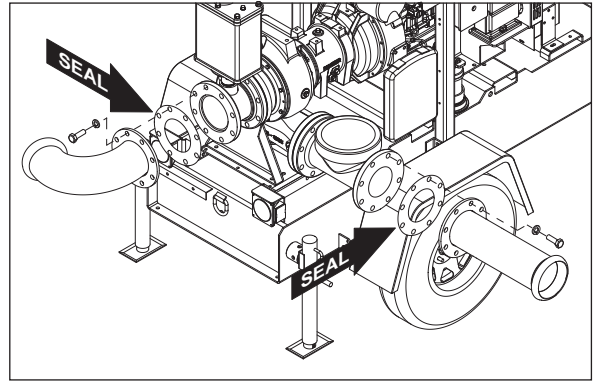

Note: Lubricate the O-ring seal with grease to ensure an airtight seal.

▲ CAUTION

The suction and discharge pipe/hose material should be compatible with the liquid being pumped.

▲ DANGER

IF A MANUAL SHUTOFF VALVE IS INSTALLED IN THE DISCHARGE LINE, IT MUST NOT BE LEFT CLOSED DURING OPERATION. A CLOSED MANUAL SHUTOFF VALVE WILL CAUSE OVERHEATING AND POSSIBLE EXPLOSIVE RUPTURE OF THE PUMP CASING. PERSONNEL COULD BE SERIOUSLY INJURED.

5. Attach a rigid intake screen or strainer to the end of the fill hose before placing it in the liquid. This will prevent large items or excessive trash from entering the pump housing. The screen must have enough openings to equal four times the area of the intake hose ($6'' \times 3.14 = 18.84 \text{ sq.in} \times 4 = 75.36 \text{ sq.in. [48,619.26 sq. mm]}$). The screen should be rigid enough to prevent collapse when flow is reduced due to clogging.
6. Place the intake hose into the liquid to be pumped. The submergence of the suction pipe into the liquid should be at least four to five times the pipe diameter. If this is not possible, provide a baffle or a floating board. This is to prevent any vortex action allowing air into the pipe/hose. For best performance, a bell mouth fitting is recommended. Refer to the Hydraulic Institute Handbooks or other Hydraulic Data books for detailed sump design information.
7. Attach a flexible hose to the outlet (discharge) side of the pump. Make sure the O-ring seal is present in the fitting on the pump before attaching the fitting.





Note: Lubricate the O-ring seal with grease to ensure an airtight seal.

8. Use a concentric taper on the discharge side to increase discharge pipe/hose diameters. All valving and additional fittings should be the same size as the discharge main-line. The discharge size should be adequate to maintain reasonable velocities and reduce friction losses.
9. Check the intake and outlet hoses for sharp bends or kinks that may restrict pump flow before proceeding. The intake hose should slope upwards toward the pump to avoid development of air pockets in the hose which may lead to pump cavitation. Keep the hoses as straight as possible.



The pump is now ready for use.

STARTING THE PUMP

Before starting the pump, be sure to check the following:

- Make sure all hose couplings, covers and plugs are tight.
 - Check the oil level in the mechanical seal oil reservoir bottle. Do not allow the bottle to run dry.
 - Check the engine oil level, coolant level and fuel level.
 - Make sure the engine starting battery is connected.
1. Make sure the Emergency Stop switch is pulled out (deactivated).
 2. Turn the Engine Start switch key to the right “RUN” position. A start-up screen will appear. After the start-up screen is cleared, the display will show readings on its virtual gauges. Once the gauges appear, crank the engine by turning and holding the key switch in the “START” position until the engine starts. See [page 13](#) for details.
 3. Allow the engine to run until it reaches a constant speed. Once it is running smoothly, the engine speed can be adjusted with the Speed Control switch ( / ), located above the Engine Start switch on the control panel.
 - A. Press and release the Rabbit  icon to increase the speed.
 - B. Press and hold the Rabbit  icon to accelerate to full speed in a few seconds.
 - C. Press and release the Turtle  icon to decrease engine speed. (Press and hold for continuous deceleration.)

Note: Venturi prime pumps prime using the vacuum created by the air from the engine compressor flowing through the jet pump. The vacuum of the jet pump is connected to the pump’s priming spool. With a flooded suction, use a bleed valve at the top of the volute to allow trapped air to escape. Rotating the pump shaft will release trapped gas in the impeller. If the pump has a float ball priming chamber connected to the priming spool, the jet pump’s vacuum line will automatically be shut when the pump is primed.

4. The pump should prime and begin to discharge liquid within minutes. A high suction lift or low engine speed will require a longer time to prime and pump.
5. Use the Speed Control switch ( / ) to adjust the pump flow. Several factors can influence pump output:
 - The temperature, viscosity, and amount of entrapped solids in the liquid being moved.
 - The length, diameter and number of bends of the intake and outlet hoses.
 - The total suction height (lift) of the pump.
 - The altitude above sea level where the pump is operating.

▲ WARNING

Never adjust the pump flow by attaching a valve to the intake or outlet side of the pump. Restricting the flow in this way can cause the pump to overheat, creating extreme pressure inside the pump volute. Explosion of the pump volute and serious personal injury may result.

6. Use the table below for approximate pump flow rates.

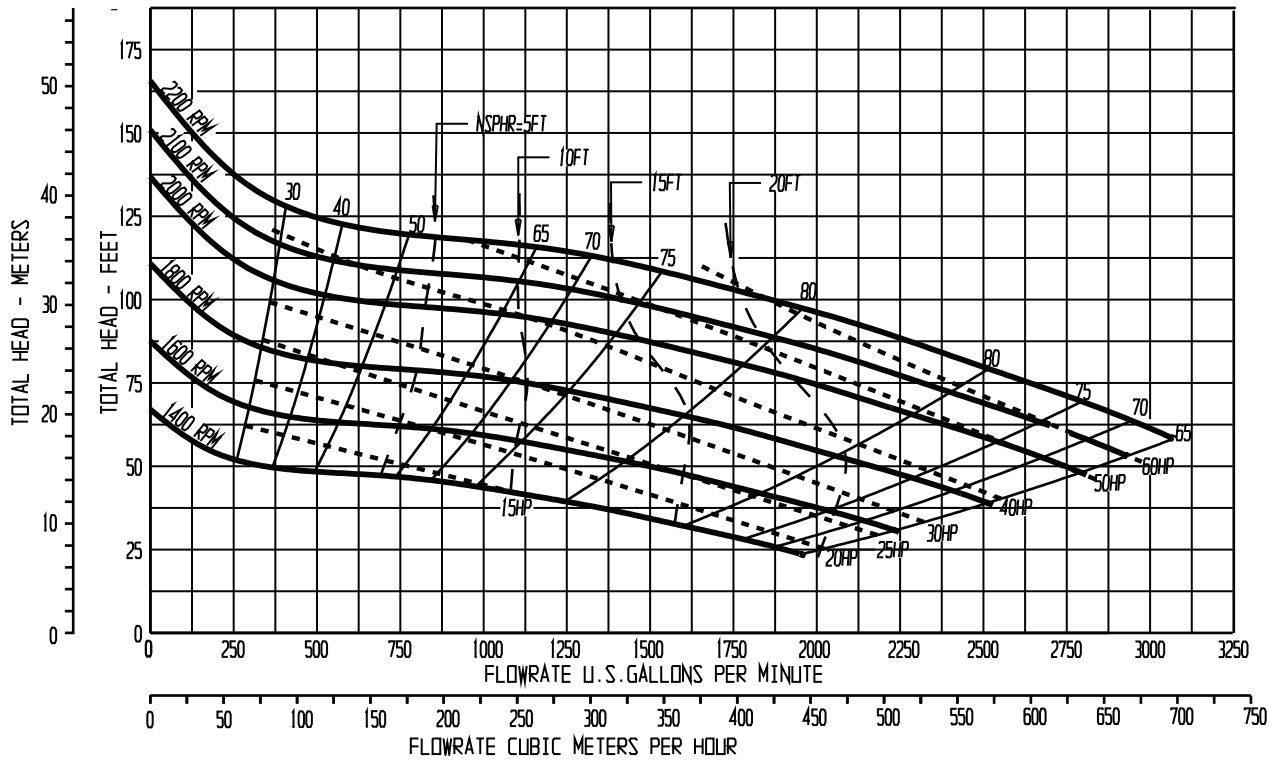

SUCTION SPECIFICATIONS

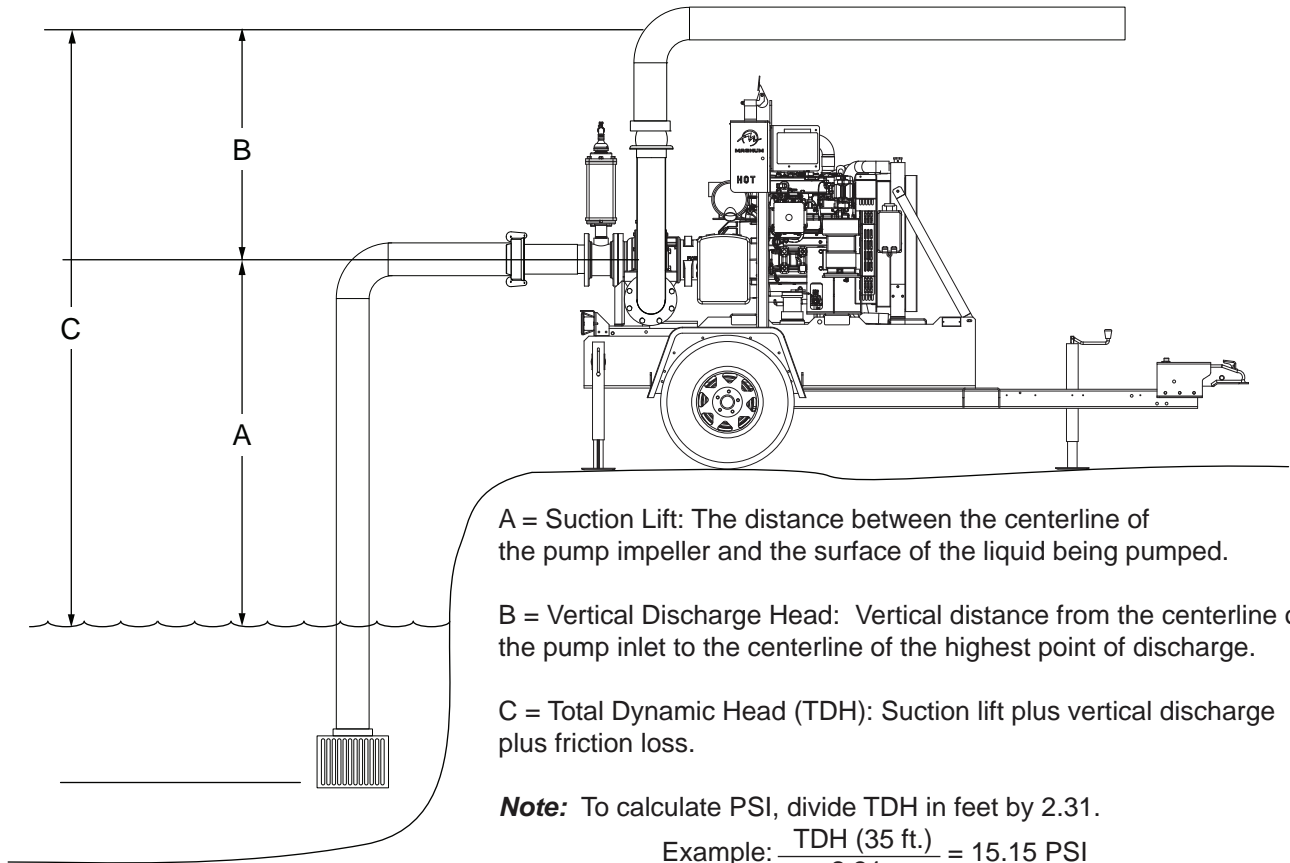

STOPPING THE PUMP

1. Reduce the engine speed by adjusting the Speed Control switch .
2. Allow the engine to idle briefly before switching the engine start switch to the "OFF" position.

NOTICE

Do not use the Emergency Stop switch unless absolutely necessary. Stopping the pump suddenly may cause shock waves to be transmitted back to the pump volute, causing pump damage. To activate the emergency stop, push the stop switch in. To deactivate the switch, pull the switch out.

3. The pump is adequately prepared for outside storage. See ["Storage" on page 42](#) for additional extended storage suggestions.

CAUTION

In freezing temperatures, drain the pump volute case of pumpage when the unit is idle to avoid freezing and possible equipment damage. Also, clean out any solids by flushing with a hose.

AUTOMATIC SHUTDOWN

The pump is equipped with a low oil pressure and a high temperature automatic shutdown system. This system will automatically shut off the fuel supply to stop the engine if oil pressure drops too low or the engine exceeds normal operating temperature. Return the engine start switch to the "OFF" position to reset the controller; restart the pump engine after you have determined the cause of the shutdown. Refer to ["Engine Fault Shutdown Troubleshooting" on page 44](#) for more information.

REMOTE/AUTO STARTING OPTION

The pump can be configured to start automatically by changing out the control box and adding dry-contact closure float level switches. Contact the Magnum Power Products Technical Service Department at 1-800-926-9768 or 1-920-361-4442 for more information on this option.

TOWING THE TRAILER

1. Raise the rear leveling jacks. Release the jack locking pins and rotate the jacks into the travel position.
2. Use the tongue jack to raise or lower the trailer onto the hitch of the towing vehicle. Lock the hitch coupling and attach the safety chains or cables to the vehicle. Release the jack locking pin and rotate the jack into the travel position. Make sure the locking pin snaps into place.
3. Connect any trailer wiring to the tow vehicle. Check for proper operation of the stop and signal lights.
4. Check for proper inflation of the trailer tires. See ["Specifications" on page 9](#) for appropriate tire pressure.
5. Check the wheel lugs. Tighten or replace any that are loose or missing. If a tire has been removed for axle service or replacement, tighten the lugs in the order shown to the following specifications:
 - A. Start all lug nuts by hand.
 - B. First pass tighten to 20-25 ft-lbs (27-33 Nm).
 - C. Second pass tighten to 50-60 ft-lbs (67-81 Nm).
 - D. Third pass tighten to 90-120 ft-lbs (122-162 Nm).

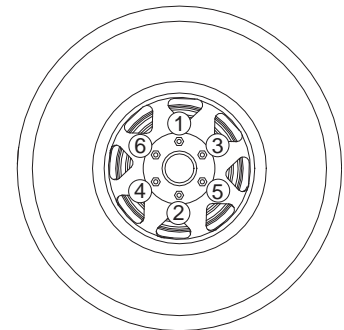

Note: After the first road use, retorque the lug nuts in sequence.

6. Maximum recommended speed for highway towing is 45 mph (72 km/h). Recommended off-road towing speed is not to exceed 10 mph (16 km/h) or less, depending on terrain.

TRAILER WHEEL BEARINGS

The trailer is equipped with a grease zerk fitting to allow lubrication of the wheel bearings without the need to disassemble the axle hub. To lubricate the axle bearings, remove the small rubber plug on the grease cap, attach a standard grease gun fitting to the grease zerk fitting and pump grease into the fitting until new grease is visible around the nozzle of the grease gun. Use only a high quality grease made specifically for lubrication of wheel bearings. Wipe any excess grease from the hub with a clean cloth and replace the rubber plug when finished. The minimum recommended lubrication is every 12 months or 12,000 miles (19,312 km). More frequent lubrication may be required under extremely dusty or damp operating conditions.

LIFTING THE PUMP

Only lift the pump with equipment that is in good condition and that is rated to support the weight of the pump. See “*Specifications*” on page 9 for approximate weights. A central lift point is located on the top of the pump. The lift point is connected to a lift structure. Attach a sling or hook directly to the lift point. Always remain aware of others around you when moving or lifting the pump. Suction and discharge hoses and piping must be removed from the pump before lifting.

Use the forklift pockets with care. Approach the unit as perpendicular as possible to avoid any damage to the unit. Make sure any obstructions are clear of the forklift tines before lifting.

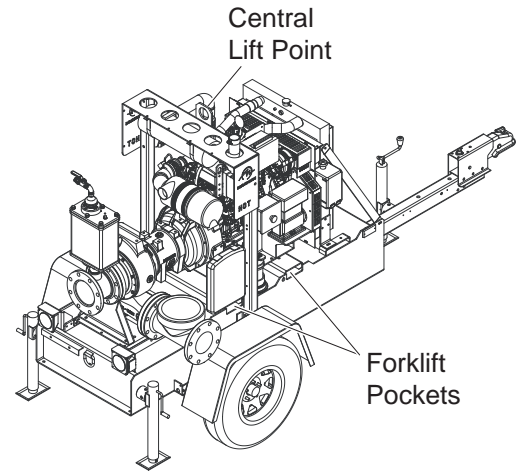

DAILY WALK AROUND INSPECTION

Look for conditions that could hinder performance or safety, such as (but not limited to) oil/coolant/fuel leakage, blocked vents, loose/missing hardware and electrical connections.

Visually inspect the engine fan belt for cracks, fraying, stretching and that the belt is properly seated in pulley grooves. Replace the belt according to the manufacturer's recommendations.

Note: At the 500 hour/12 month service interval, it is recommended that the belt be removed and checked for wear. While the belt is removed, inspect pulleys and bearings. Rotate and feel for hard turning or unusual sounds. If pulleys or bearings need replacement, contact John Deere.

NOTICE

Failure to perform a daily inspection may result in serious damage to the prime mover.

ENGINE AND PUMP MAINTENANCE

Poorly maintained equipment can become a safety hazard. In order for the equipment to operate safely and properly over a long period of time, periodic maintenance and occasional repairs are necessary. **NEVER** perform even routine service (oil/filter changes, cleaning, etc.) unless the engine start switch is turned to “OFF/O” and the negative (-) cable on the battery is disconnected. Attach a “DO NOT START” sign to the control panel. This will notify everyone that the unit is being serviced and will reduce the chance of someone inadvertently trying to start the unit.

Never wash the unit with a high pressure hose or with any kind of power washer. Never wash the engine block or fuel tank with a power washer or steam cleaner. Water may collect in the pump control panel or other electrical parts, causing damage.

BASIC MAINTENANCE SCHEDULE (JOHN DEERE ENGINE)

NOTICE

Refer to the original equipment manufacturer's operating manual for a complete list of maintenance requirements. Failure to comply with the procedures as described in the engine operator's manual will nullify the warranty, decrease performance, and cause equipment damage or premature equipment failure. Maintenance records may be required to complete a warranty request.

Use the schedule in the following table as a guide for regular maintenance intervals. For additional or replacement copies of the engine operator's manual, contact an authorized dealer in your area.

Item	Daily	250 Hrs.	500 Hrs./12 Months	2000 Hrs./ 24 Months	As Required
Check Oil Level	◆				
Check Coolant Level	◆				
Check Fuel Level	◆				
Check Tire Pressure	◆				
Check All Electrical Connections	◆				
Inspect Radiator Fins For Debris, Clean As Required	◆				
Check Fuel Filter	◆				
Check Air Cleaner Dust Unloader Valve and Indicator	◆*				
Perform Visual Walkaround Inspection	◆				
Check Mechanical Seal Oil Level (page 41)	◆				
Check Flange Fitting Hardware	◆				
Check Condition of Wear Plate		◆			
Change Mechanical Seal Oil (page 41)		◆			
Check Condition of Volute Seals		◆			
Lubricate Pump Bearings (page 41)		◆			
Check Oil Vapor Recirculation System/Non-Return Valve		◆			
Replace Oil Vapor Recirculation Filter			◆		
Change Engine Oil and Replace Oil Filter			◆**		
Replace Fuel Filter Element			◆		
Check Air Intake System			◆		
Check Belt Tensioner Spring Tension and Belt Wear			◆		
Check Engine Electrical Ground Connection			◆		
Check Engine Mounts			◆		
Service Battery			◆		
Check Cooling System			◆		
Lubricate Leveling Jack(s)			◆		
Check Compressor Mounting Hardware			◆		
Test Thermostats				◆	

Item	Daily	250 Hrs.	500 Hrs./12 Months	2000 Hrs./ 24 Months	As Required
Check Flex Coupling Condition				◆	
Check Pump To Engine Hardware				◆	
Add Coolant					◆
Replace Air Cleaner Elements					◆
Replace Poly-Vee Belt					◆
Check Fuses					◆
Bleed Fuel System					◆

* Replace primary air cleaner when dust valve restriction indicator gauge shows a vacuum of 25 in. H₂O.

** Change the oil and oil filter after the first 100 hours, then every 500 hours.

BELT TENSIONERS

John Deere engines use two types of belt tensioners: manual and automatic. Adjust the belt using the manual tensioner according to the manufacturer's specifications. The automatic tensioner cannot be adjusted or repaired and is designed to maintain proper tension over the belt's life. Units with the automatic belt tensioner must be inspected according to the manufacturer's specifications.

SERVICING THE PUMP

▲ WARNING

Before attempting to service the pump, read this manual carefully. Operating and maintenance personnel should have a good understanding of all aspects of this pump and the pumping conditions. Failure of operating personnel to be familiar with all aspects of pump operation outlined in this manual could contribute to equipment damage, bodily injury, or possible death.

Before servicing:

1. Verify that the Engine Start switch is turned to "OFF" and the negative (-) cable on the battery is disconnected.
2. If the pump or components are hot, allow adequate cooling prior to servicing the unit.
3. Close the suction and discharge valves.
4. Vent the pump slowly and drain completely.

▲ WARNING

If this pump is used to handle any hazardous materials that can cause injury or illness, take precautions by wearing approved protective clothing and use appropriate safety equipment.

▲ WARNING

Use lifting and moving equipment that is in good condition and that has adequate capacity to prevent personal injury or equipment damage. When lifting the pump end with chains or cables, position them so the load is balanced and so pump damage will not occur. Suction and discharge hoses and piping must be removed from the pump before lifting.

When servicing this pump, use only components provided by Magnum Power Products LLC. Any use of non-authorized parts could result in sub-standard performance, damage to equipment and possible injury to personnel. Use of unauthorized parts will also void the warranty.

Refer to [“Pump Troubleshooting” on page 43](#) to help diagnose operational or performance problems. Only disassemble the pump components required to remedy the problem condition. For further visual reference, see the [“Pump Component Drawing” on page 46](#) of this manual or the appropriate part assembly in the parts manual.

Select a clean suitable location for any required maintenance, and note that all work must be performed by qualified personnel. An ongoing record of performance will assist in any troubleshooting and/or analysis of problems. A pressure gauge can be installed on the suction and discharge side of the pump to monitor any changes in differential pressure. Differential pressure is useful in monitoring and diagnosing any possible degradation in pump performance.

PUMP MAINTENANCE PROCEDURES

PRIMING CHAMBER

Disconnect and remove suction piping and air tubing from the priming chamber/suction spool assembly. While supporting the assembly with a sling, remove the nuts and bolts connecting the suction spool to the pump suction flange.

PRIMING VALVE SERVICING

The priming valve system, housed inside the priming chamber, is adjusted at the factory and should rarely require service. It is possible, after extended use, that wear of the holes in the upper arm, lower arm, link or pins could necessitate slight adjustment of the stem washer to upper arm clearance. Furthermore, it may become necessary to adjust the valve spring tension.

Adjustment Instructions:

With the forked portion of the upper arm parallel to the stem washer, the gap between them should be .03 to .09 in (.76 to 2.28 mm). If this gap is too large, place a shim between the actuator bracket and the priming chamber lid. This will lower the bracket and reduce the gap allowing the valve to open up as necessary to draw a vacuum more efficiently.

Note: *If the valve has still failed to open properly when the gap is shimmed correctly, the spring tension needs to be reduced. This is done by adding one or two 1/4 in. stainless flat washers between the stem and valve washer.*

To replace the stem O-ring, remove the elbow attached to the outlet of the priming chamber. This will expose the internal valve components. Grasping the lower end of the valve stem, remove the nut and washer located on top of the valve washer. Remove the valve washer and valve spring. The valve stem can now be removed through the bottom side of the priming chamber lid. Cut the old stem O-ring to remove it, and simply “roll” a new O-ring into place. Reassembly is the opposite of disassembly.

DISCHARGE CHECK VALVE

Support the check valve with a sling and remove the nuts, bolts, and gasket between the check valve and pump discharge flange. If the check valve disc needs to be replaced, remove the top cover and insert new disc. The top cover gasket should be replaced at this time.

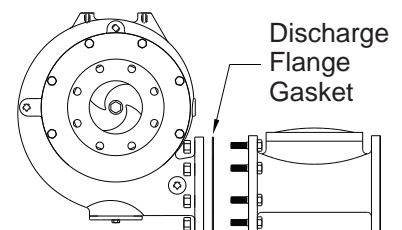
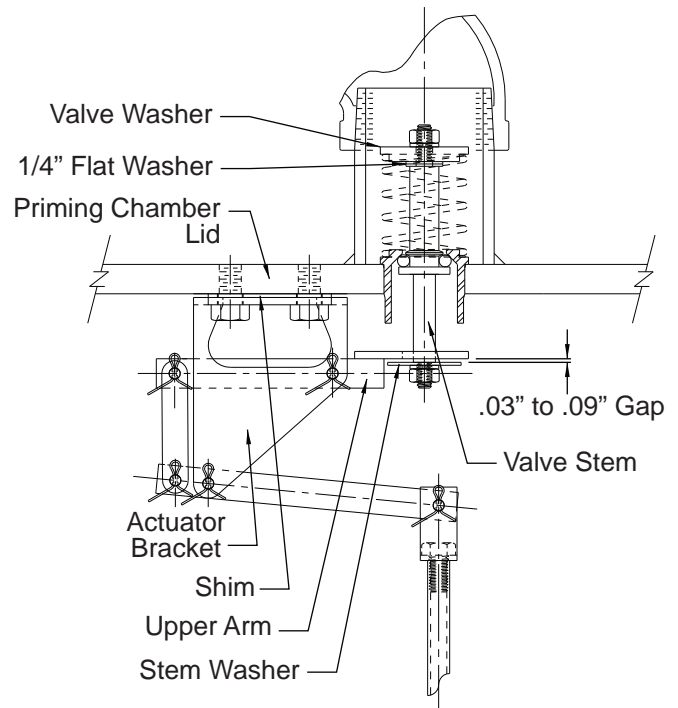
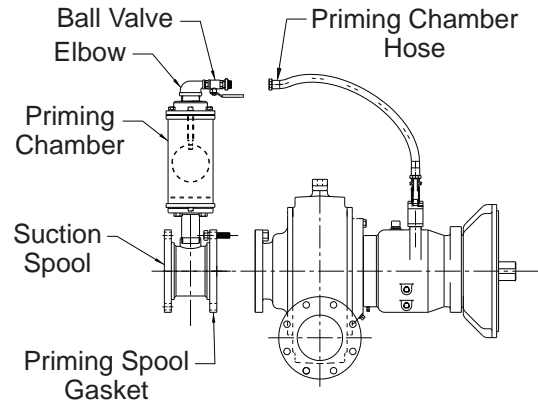

SUCTION COVER AND WEAR RING

If the pump is equipped with an external balance line, it must be removed prior to removing the suction cover. Disconnect the balance line from either the suction cover, suction spool or the backplate. Support the suction cover using a suitable sling. Remove the capscrews between the suction cover and volute. Jack screw holes are provided in the suction cover to aid removal from the volute. Insert two of the capscrews attaching the suction cover to the volute into the jack screw holes and tighten them evenly to jack the suction cover free of the volute. If the suction wear ring shows grooves or uneven wear, it should be replaced. Minor irregularities can be addressed with a fine file and crocus cloth. Wear rings may be reworked by light machining, if proper equipment is available to correct minor irregularities. After the removal of any stock, the ring must remain within allowable clearances for maximum performance. (Consult factory for clearances for specific models.)

When the pump performance drops below acceptable limits, the suction wear-ring and hub wear ring (if so equipped) should be replaced. These rings can be removed by drilling two holes of adequate size, axially, through the ring 180° apart. The ring can now be collapsed and removed.

Tap the new ring into place evenly around its circumference, with the chamfer toward the suction flange. Anti-seize lubrication should be applied to the outside diameter of the ring prior to installation in the suction cover. Make sure the wear ring is installed tight against the shoulder.

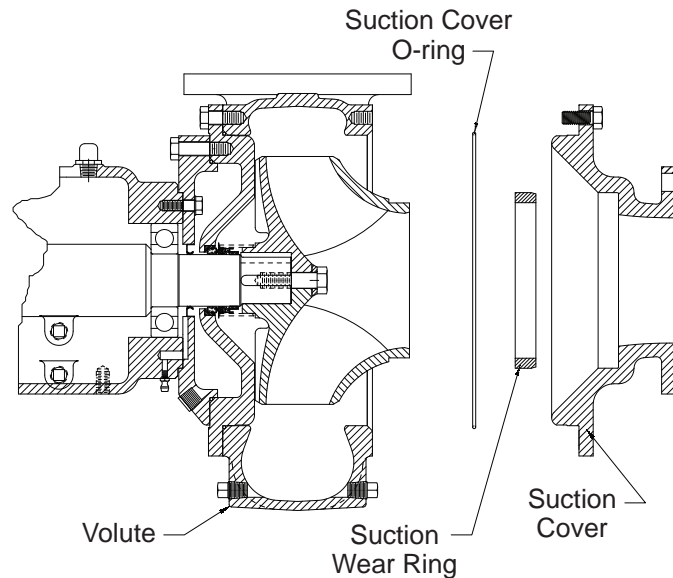

Note: This pump is equipped with a run-dry feature for mechanical seal protection. Prior to any further disassembly of this pump, the external oil reservoir and auxiliary gland should be drained.

IMPELLER REMOVAL

Remove the impeller lock screw and washer at the center of the impeller. Utilizing a properly sized gear puller, evenly pry between the back shroud of the impeller and the backplate. Take care not to lose or damage any impeller shims that may be inside the impeller bore, and do not lose the impeller key. As the impeller is being removed from the shaft, ensure that the seal spring, if present, is not lost or damaged. Inspect the impeller and replace or repair it if

necessary.

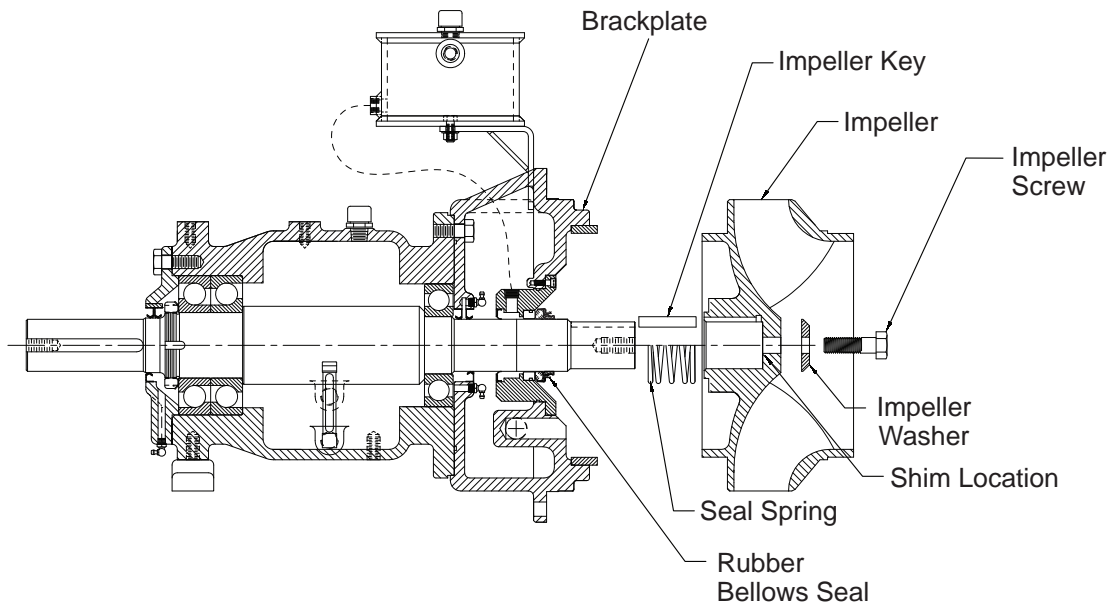

SEAL REMOVAL (ROTATING ELEMENT)

Once the impeller is removed, the rotating assembly of the seal (bellows, spring and retainer) can slide off of the shaft as a unit. Apply a light coat of oil to the shaft to help free the rotating assembly. Take care to protect this assembly from any foreign matter or damage.

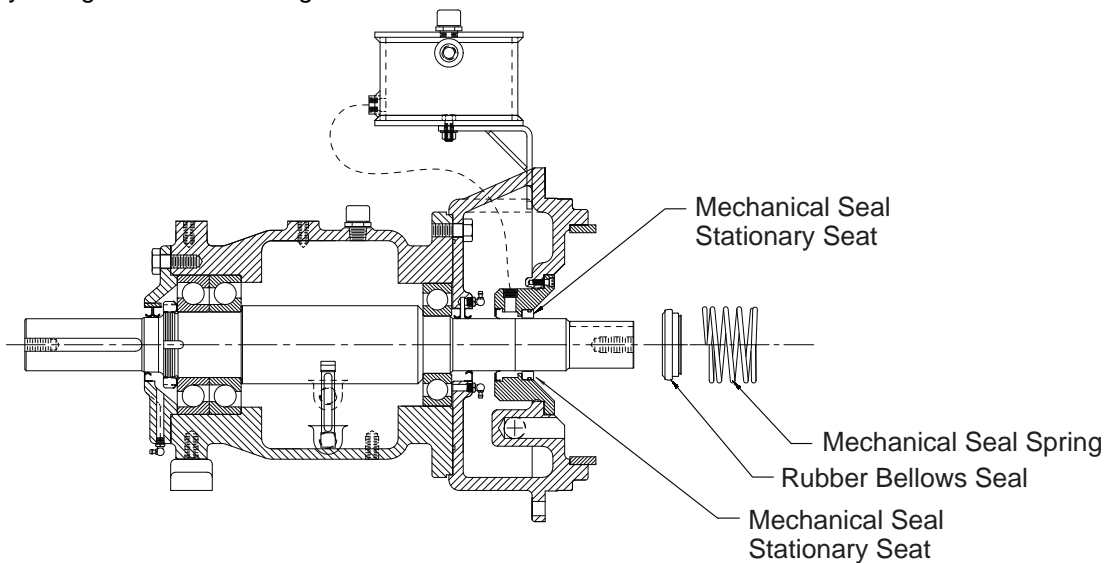

BRACKPLATE REMOVAL

The brackplate can now be removed by removing the capscrews between the brackplate and the bearing housing. A sling or other support should be attached to the brackplate prior to its removal. Slide the brackplate straight off of the shaft to prevent any damage to the stationary seal seat or the surface of the shaft. Care should also be taken to avoid damaging the brackplate lipseal(s) or the run-dry gland lipseal. The mechanical seal stationary seat can now be pressed out of the brackplate bore, taking care not to break the seat. The entire seal assembly can now be

inspected for any damage that will require replacement or reconditioning.

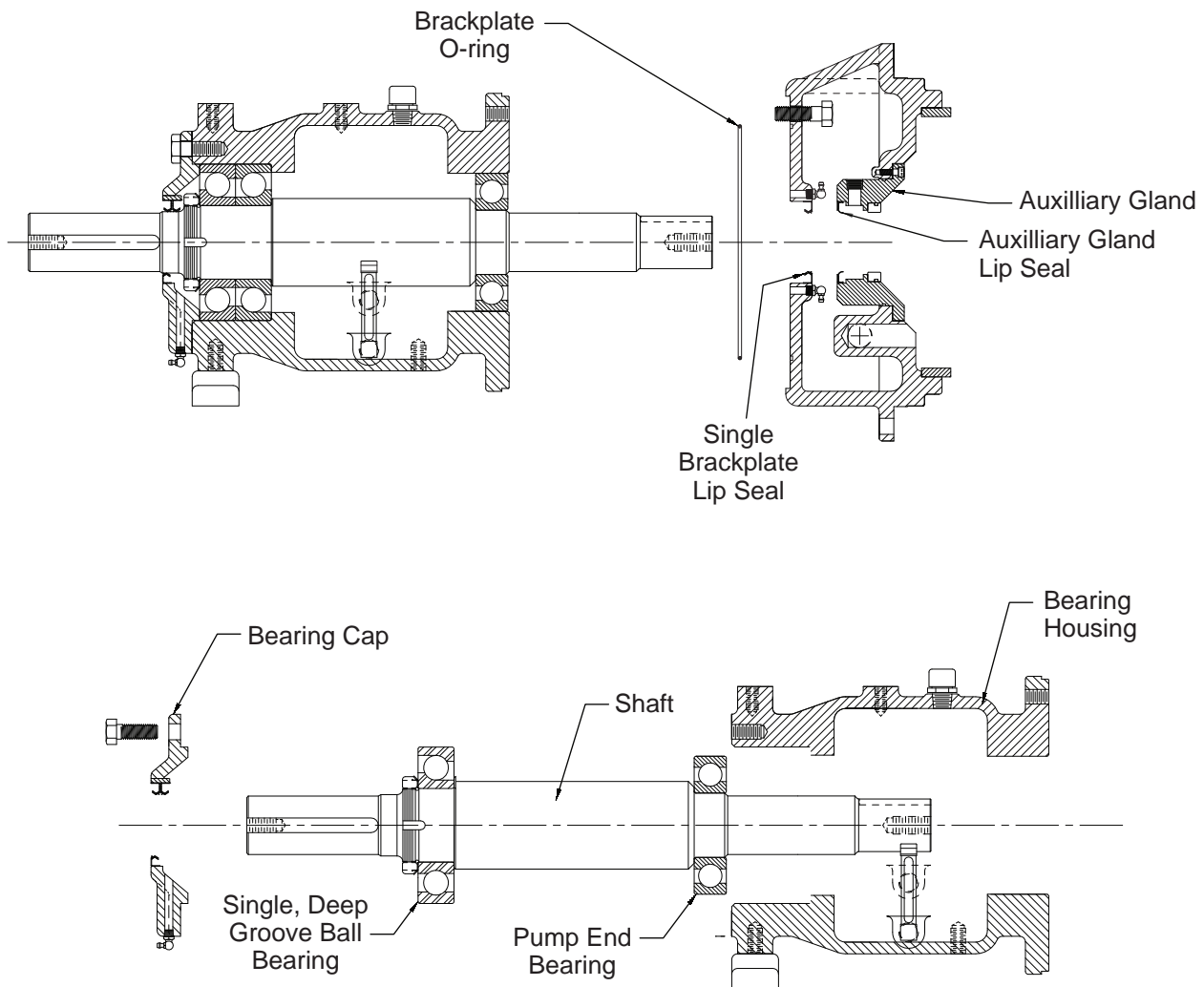

BEARING HOUSING

If the frame bearings require servicing, it will be necessary to remove the bearing housing from the driver and the pump end from the bearing housing. Remove the coupling guard as necessary. With the bearing housing supported with a hoist and sling, remove bolts holding the housing to the baseplate. Now the bearing housing can be moved away from the driver for further servicing.

On the drive end of the bearing housing, remove the capscrews holding the bearing housing cover or the SAE bracket to the housing. Gently slide the housing cover or the SAE bracket off of the shaft to protect the lip seal(s) if it is to be reused.

Now the shaft assembly, including the shaft, bearings, and the bearing locknut and washer, can be removed through the drive end of the bearing housing. This operation may require placing a block of wood against the impeller end of the shaft and tapping with a "dead blow" hammer, or using a mechanical or hydraulic press against the impeller end of the shaft. If the bearings are to be re-used, the shaft should be pressed out rather than tapped out with a hammer. With the shaft and bearing assembly out of the housing, the bearings can be inspected and replaced as necessary.

▲ CAUTION

To prevent equipment damage and personal injury, any work on the shaft and bearing assembly should be done in a properly equipped shop by experienced personnel.

Bearings should be replaced any time they are removed from the bearing housing. Clean the bearing housing, shaft,

and other components, except the bearings, with cleaning solvent and a string/lint-free cloth. Inspect all parts and blow components dry with compressed air. If the bearings are to be replaced, the old bearings can be removed using a suitable gear puller. It is recommended that brackplate and bearing cap lip seals also be replaced at this time. These lip seals can be driven out of their bores with a drift, punch or screw driver. Before removing the lip seals, note the orientation of the lips, and be certain to install the new seals with the same orientation. When driving or pressing in the lip seals, use a flat block or plate which applies pressure around the entire circumference of the seal – do not drive the seal in with a drift or punch.

▲ WARNING

When using cleaning solvent, be sure to have adequate ventilation as most solvents are toxic and flammable. Follow all precautions pertaining to the solvent and keep area free from excessive heat, sparks and flame.

Rotate the bearings by hand and check for any roughness or wear. If any roughness, wear or discolored areas are present, replace the bearings. Also, check the fit between the bearings and shaft for a tight press fit and between the bearings and the housing for a snug slip fit. If the fits are not correct, then replace the bearings, shaft, or the bearing housing as indicated by wear. If bearings are to be replaced, use a bearing puller to remove them from the shaft.

BEARING HOUSING REASSEMBLY

After all components have been inspected, repaired, and/or replaced, ensure all parts are clean and ready for assembly as indicated above. Use extreme caution during assembly to protect all parts from dirt and damage. The bearings should be installed using the bearing manufacturer's recommended installation procedure.

If heat is used to install the bearing, use an induction heater, electric oven, or hot plate. Do not use a direct flame. Heat the bearings to a uniform temperature of 220°F (105°C) maximum and slide each bearing onto the shaft until firmly seated against the shaft shoulder. Once the bearing is removed from the heat, it must be placed over the shaft and seated against the shoulder very quickly or it will seize to the shaft in the wrong position. After the bearings have cooled; ensure that they are still seated against the shaft shoulder. If they are not seated, use a sleeve, of the correct size, and a press to seat bearing. This sleeve and press can be used if heating the bearing is not practical, but only press against the inner race of the bearing.

With the drive end bearing firmly seated against the shaft shoulder, install the bearing lockwasher and the bearing locknut. Refer to the figure below for the correct orientation. Ensure the washer tab on the inside diameter is engaged in the slot in the shaft and the tab is pointed toward the bearing. After the bearing nut has been tightened, bend one of the tabs on the outside diameter of the washer to engage one of the slots in the nut.

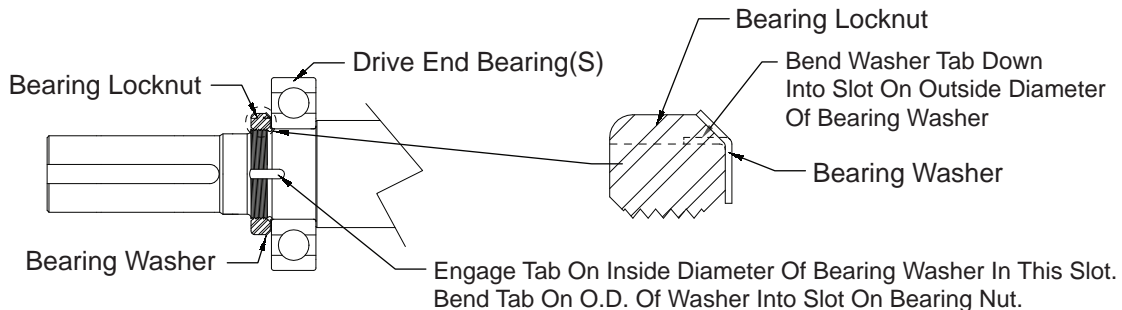

Some pumps are equipped with double angular contact bearings at the drive end. It is imperative that these bearings be installed in the correct orientation relative to one another. When installing the first of the two angular contact bearings onto the shaft make certain that the side of the inner race with the largest diameter is located against the shaft shoulder. The next bearing must be installed with the smaller diameter side of the inner race against the first bearing.

Check that the bearing housing is clean and that the bearing bores are free of any burrs or nicks. Ensure the bearing housing spacer (not used with double drive end bearings) is installed in the drive end bore of the housing. Wait for the bearing to cool, then, from the drive end of the bearing housing, slide the shaft/bearing assembly into the drive end of the housing. Press the drive end of the shaft until the drive end bearing contacts the housing or bearing spacer shoulder.

Apply a light coat of oil or grease to the bearing cap lip seal(s) that is installed in the SAE bracket. Slide the bearing cap or SAE bracket over the drive end of the shaft, taking care to protect the lip seal. Secure the bearing cap to the bearing housing using the capscrews. For oil lubricated bearing frames, make sure that the bearing cap O-ring is installed on the bearing cap register. Moving the shaft in both axial directions should produce a total endplay between 0.002 and 0.010 in (.05 and .25 mm). Use bearing shims to limit endplay to this range.

FLYWHEEL COUPLING INSTALLATION

Pumps purchased with SAE brackets and flywheel couplings are shipped with the coupling mounted to the shaft in the correct axial location for engines with bell housings and flywheels manufactured to SAE standard dimensions.

NOTICE

If the pump is to be mounted to the engine by other than Magnum Power Products LLC factory personnel, the assembler must take full responsibility to verify the pump shaft does not bear against or make any contact with the engine crankshaft or flywheel. Also make sure the flywheel coupling is mounted in such a position so as not to transmit any axial thrust to the flywheel. Failure to verify this could result in severe engine damage.

Bolt the aluminum drive ring of the flywheel coupling to the flywheel register and torque the fasteners (grade 8) to 372 in-lbs (42 Nm). Place the notched key into the taperlock bushing and position the rubber element and taperlock bushing on the shaft as shown in the illustration (refer to the preceding notice). Torque the taperlock bushing screws to 430 in-lbs (49 Nm).

Note: Dimensions shown are based on SAE standard bellhousing and flywheel dimensions. The installer assumes full responsibility for verifying dimensions are correct for their specific engine.

BRACKPLATE TO BEARING HOUSING REASSEMBLY

Apply a coat of oil or grease to the brackplate lip seal(s) and to the run-dry gland lip seal (if present). Slide the brackplate over the pump end of the shaft, protecting the lip seals. Check that the brackplate drain port is located in the bottom position. Secure the brackplate to the bearing housing using the capscrews provided.

If the pump is grease lubricated, both bearings should be initially packed with grease before reinstalling the bearing cap and brackplate. A hand operated grease gun should be used, after reassembly of the brackplate to the bearing housing, to inject two or three "pumps" of grease between these seals.

SEAL REASSEMBLY

Always handle all seal parts with extreme care to prevent damage. Be especially cautious not to contaminate the precision finished mating faces as even fingerprints can shorten seal life. If required, clean the faces with a non-oil based solvent and a clean, lint-free cloth. Use a concentric pattern while wiping to prevent scratching the faces.

Carefully inspect all seal parts for any damage or wear. Any scoring or grooves in the mating faces could cause the seal to leak, so it should be refurbished and mating faces relapped or replaced with a new complete seal assembly.

Clean the shaft and remove any nicks, cuts, or burrs. Lubricate the outside diameter of the seat O-ring with 30 wt. to 80 wt. motor oil or hydraulic hose assembly lube and apply a drop of light lubricating oil to the seal faces. Lubricate the seat bore of the brackplate and ensure it has a chamfer.

Slide the stationary seat over the shaft and carefully press it into the bore of the brackplate. Ensure the stationary seat is squarely seated into the brackplate. Lubricate the shaft surface and the inside diameter of the rubber bellows. Also spray the stationary seal face with penetrating oil to create a film. Now slide the rotating element over the shaft up to the stationary seat, with the polished face (primary ring) of the rotating element toward the polished face of the seat. Slide the spring over the outside of the seal assembly up to the retainer flange.

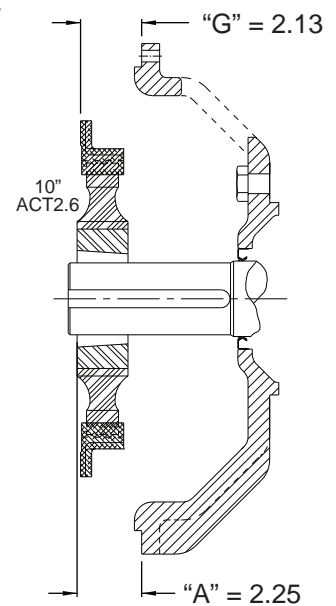

IMPELLER REASSEMBLY

Inspect the impeller for any cracks or badly worn areas. Replace if necessary. Install the impeller key and slide the impeller over the shaft. Ensure that the seal spring is in place over the outside diameter of the impeller hub. Install the impeller washer and impeller lock screw (use #262 red Loctite™ on the threads of the impeller lock screw when reinstalling in the shaft) and tighten. See [“Torque Values” on page 42](#).

For impellers that are equipped with back vanes rather than a hub wear-ring, use the following procedure: With the impeller firmly against the shaft end, measure the gap between the back vanes of the impeller and the face of the brackplate. Remove the impeller and place impeller shims (0.005, 0.010 and 0.015 in [.127, .254, .381 mm] thick) in the bore of the impeller until the gap is the same as it was when originally removed. Each time the impeller is installed on the shaft make sure the seal spring is in place over the outside diameter of the impeller hub. Once the desired gap between the back vanes and brackplate is attained, install the impeller washer and impeller screw (use #262 red Loctite™ on the threads of the impeller screw when reinstalling it on the shaft) and tighten. See [“Torque Values” on page 42](#).

VOLUTE REASSEMBLY

Place a new O-ring over the register of the suction cover, lubricate with grease and seat it against the cover face. Secure the suction cover to the volute with the appropriate capscrews. Refer to [“Suction Cover And Wear Ring” on page 36](#) for replacement, if required.

DISCHARGE CHECK VALVE REASSEMBLY

Install the gasket and secure it to the discharge nozzle with bolts and nuts. Ensure that the check valve is installed for the correct flow direction. Refer to the discharge check valve parts illustration on [page 35](#) if any repairs are to be made.

PRIMING CHAMBER REASSEMBLY

Install the gasket and use nuts and bolts to attach the priming chamber, with spool, to the suction flange of the pump. Refer to the Priming Chamber/Valve sections on [page 35](#) if any repairs or adjustments are required.

LUBRICATION - BEARING FRAME

The lubrication of the ball bearings depends on speed, load, ambient temperature, contamination, moisture, intermittent or continuous service, and other factors. Typically, re-greasing should occur every 250 hours of operation.

To lubricate the ball bearings, remove the plastic covers from the zerk fittings. Ensure that the zerk fitting and the end of the grease gun are clean. Use only a hand-operated grease gun with ball bearing grease. Use one of the following, or equivalent: Texaco Starplex Moly 2, Mobile Mobilux No. EP2, Shell Alvania EP2, Chevron SRI.

LUBRICATION - SEAL OIL RESERVOIR

This pump is provided with a seal oil reservoir that permits this unit to run dry. The reservoir supplies lubrication and cooling to the outboard side of the mechanical seal without any liquid in the pump. Check the oil level in the reservoir and add oil as needed. During normal operation, it is suggested to change this oil every three months. If the oil shows indications of contamination or discoloration, change the oil more frequently. The oil reservoir is filled via the cap at the top of the bottle. There is a petcock located on the opposite side of the auxilliary gland from the oil inlet line. During initial filling, this petcock should be opened to allow the air to vent from the gland. Continue to add oil until no air is present in the line and oil comes out of the petcock.

Use turbine oil with an ISO rating of 32 or lower. If you have unusual pumping conditions, contact Magnum Power Products LLC. Oil used in the reservoir (bottle) should be ISO VG 32 Turbine Oil or automatic transmission oil, equivalent to one of the following manufacturer's products: Chevron Turbine Oil GST 32, Mobile DTE 797, Shell Turbo T Oil 32.

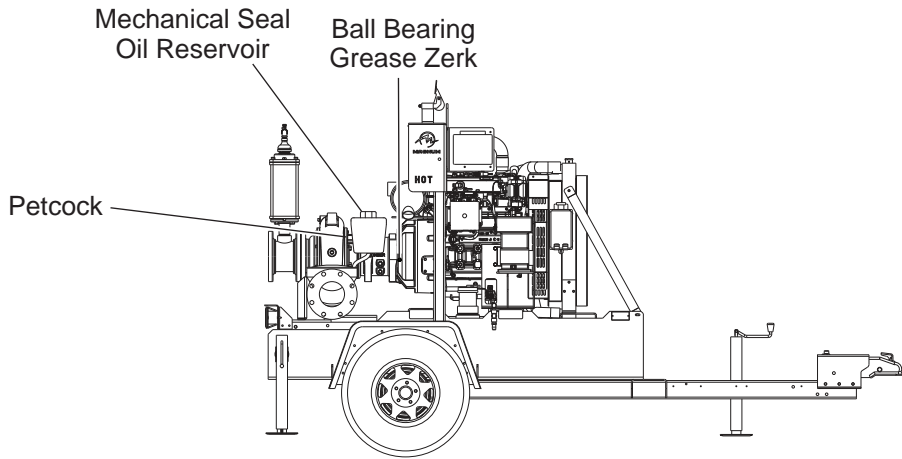

TORQUE VALUES

SIZE UNC	MATERIAL		
	304 SS	GRADE 5 BOLTS	GRADE 8 BOLTS
¼	3.0 ft-lb	9 ft-lb	13 ft-lb
5/16	7.0 ft-lb	19 ft-lb	27 ft-lb
3/8	13 ft-lb	34 ft-lb	48 ft-lb
7/16	20 ft-lb	54 ft-lb	77 ft-lb
1/2	31 ft-lb	83 ft-lb	117 ft-lb
9/16	45 ft-lb	120 ft-lb	170 ft-lb
5/8	63 ft-lb	165 ft-lb	234 ft-lb
3/4	112 ft-lb	293 ft-lb	415 ft-lb
7/8	180 ft-lb	474 ft-lb	670 ft-lb
1	270 ft-lb	710 ft-lb	1000 ft-lb
1 1/4	540 ft-lb	1421 ft-lb	2000 ft-lb

Note: The above values are general in nature. If a grade 2 or 5 capscrew is threaded into stainless steel, use the lower value, i.e. 304 stainless.

STORAGE

The unit is adequately prepared for outside storage prior to shipment. Use the following list of additional suggestions for extended storage.

1. Disconnect the battery cables.
2. Store the unit off the ground so no water will accumulate around the equipment.
3. Protect unit from blowing sand and dirt.
4. Stack no other items on top of pump/equipment.
5. Protect unit from the entry of any animals.
6. Periodically rotate shaft to lubricate bearings and protect bearings from brinelling.
7. Protect unit with approved drying agents (Silica Gel).
8. Ensure all bare metal areas are coated with rust preventative.
9. Inspect unit every four weeks and replace drying agents (Silica Gel) as required, or a minimum of every six months.
10. Keep an inspection record showing dates of inspection with any maintenance performed and condition of drying agents (Silica Gel).

11. Before use ensure that all rust protection has been removed. Also, remove any foreign material that may have accumulated during storage.
12. Before use remove all drying agents (Silica Gel).

PUMP TROUBLESHOOTING

Symptom	Possible Cause
No discharge	1,2,3,4,5,7,8,9,10,17,18,19,20,37
Reduced capacity	2,3,4,5,7,8,9,10,11,17,19,20,21,38,39,40,47
Reduced pressure	5,7,8,11,13,18,19,38,39,40,47
Loss of prime	2,3,4,7,10,11,20,21,22,23
Power consumption excessive, engine runs hot	6,12,13,17,18,19,24,33,34,35,36,37,38,41,42,43,44
Vibration and noise	2,4,9,10,14,15,17,26,27,28,29,30,31,32,33,34,35,36,39,40,41,42,43,44,48
Seal: excessive leakage, short life, seal housing overheating	22,23,25,33,34,35,36,41,44,45,46
Bearings: overheating, short life, noise	26,27,28,29,30,31,32,33,34,35,36,41,42,43,44
Pump overheating, seizes	1,8,9,14,33,34,35,36,41,42,43,44
Corrosion, erosion, pitting, oxidation or other loss of material	7,8,11,14,15,16

- | | | |
|---|--|---|
| 1. Pump not primed | 16. Electrolysis | 34. Temperature growth |
| 2. Suction line not filled | 17. Impeller obstructed | 35. Misalignment |
| 3. Air pocket in suction line | 18. Rotation direction wrong | 36. Coupling improperly installed |
| 4. Suction inlet or foot valve obstructed, insufficiently submerged, or too small | 19. Low speed | 37. Impeller installed backwards |
| 5. System head higher than pump design head | 20. Air leak into suction line | 38. Worn wear rings |
| 6. System head lower than pump design head | 21. Air leak through mechanical seal | 39. Impeller damage |
| 7. Insufficient NPSH | 22. Seal fluid contaminated, hot or insufficient | 40. Improper balance (after repair) |
| 8. Parallel pump application is incorrect | 23. Seal fluid system not vented | 41. Bent shaft |
| 9. Suction pressure to vapor pressure below minimum | 24. High speed | 42. Excessive thrust |
| 10. Suction lift too high | 25. Mechanical seal insufficient | 43. Rotational element dragging |
| 11. Excess vapor in pumpage | 26. Bearing housing excessively cooled | 44. Worn or incorrectly installed bearings |
| 12. Specific gravity of pumpage housing different than design | 27. Low oil pressure (oil lube bearings) | 45. Mechanical seal not properly set, O-rings damaged or hardened |
| 13. Viscosity of pumpage different than design | 28. Improper or poor lubrication | 46. Shaft scored at seal |
| 14. Operation at below rated capacity | 29. Lubrication defective | 47. Volute O-ring |
| 15. Cavitation | 30. Dirt in lubrication/bearings | 48. Foundation not rigid or settled |
| | 31. Moisture in lubricant/bearing housing | |
| | 32. Lubricant excess | |
| | 33. Pipe strain | |

ENGINE FAULT SHUTDOWN TROUBLESHOOTING

Symptom	Possible Cause	Solution
Low oil pressure shutdown	Low oil level	Check oil level, replace as necessary
	Faulty oil pressure sender	Replace oil pressure sender
	Incorrect oil grade	Change engine oil, consult engine operator's manual
	Worn oil pump	Consult engine operator's manual
	Oil leak	Consult engine operator's manual
High temperature shutdown	Low coolant level	Check coolant level, replace as necessary
	Faulty temperature sender	Replace temperature sender
	Coolant leaks	Consult engine operator's manual, replace components as necessary
	Worn water pump	Consult engine operator's manual
Overcrank shutdown	Pump engine will not start	Consult engine operator's manual
Overspeed shutdown	Pump cavitation	Reduce engine speed, lower intake hose
	Air trapped in intake hose	Relocate and/or straighten intake hose
	Intake insufficiently submerged	Lower intake hose
	Air leak in intake hose	Inspect intake hoses and couplings for damage or missing components and seals
	Air leak at pump housing	Inspect gaskets, seals and O-rings at pump intake flange, cleanout cover and priming port
No speed signal shutdown	Engine magnetic pickup damaged or misaligned	Inspect magnetic pickup for damage/alignment
Low fuel shutdown	Low fuel level	Refill fuel tank with clean diesel fuel
Low coolant shutdown	Low coolant level	Allow engine to cool. Check coolant level in radiator. Add coolant until it is 3/4 in (19 mm) below the filler neck

CONTROL SYSTEM TROUBLESHOOTING

Symptom	Possible Cause	Solution
Control system does not perform self test	Tripped overcurrent protection	Correct fault, replace or reset overcurrent protection
	Faulty connection to battery	Correct battery connections
	Faulty control system	Repair or replace control system
Display does not display data	Display lost power	Turn on key, verify display plugged into harness
	Engine source address incorrect	Change engine address in configuration
	Display address incorrect	Change display address to 40 (default)
	Display configuration problem	Reset display using Restore Defaults
	CANbus failure	Check CANbus (see Testing CANbus)
	ECU not sending data	Repair or replace ECU

PUMP COMPONENT DRAWING

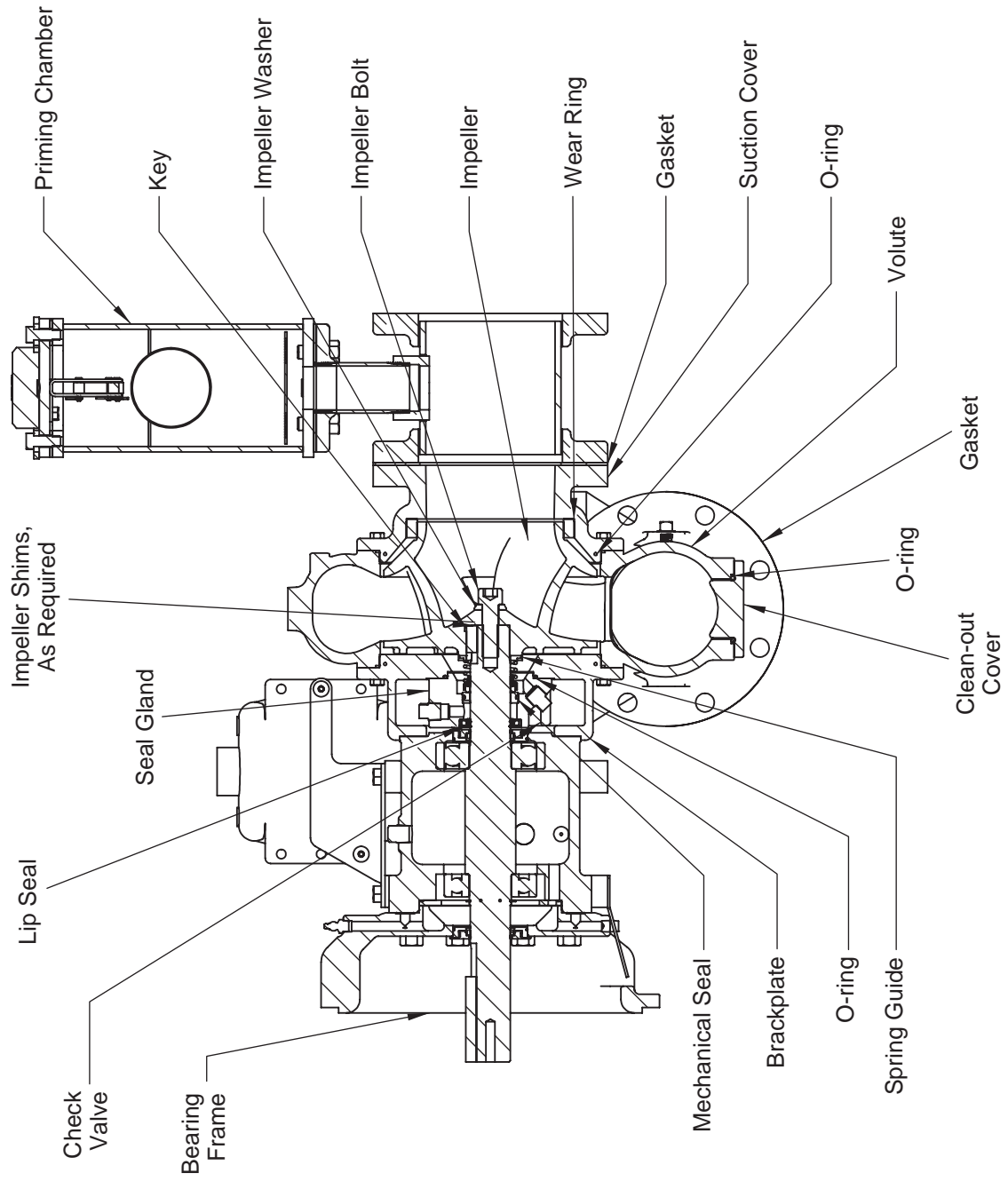

DC WIRING DIAGRAM

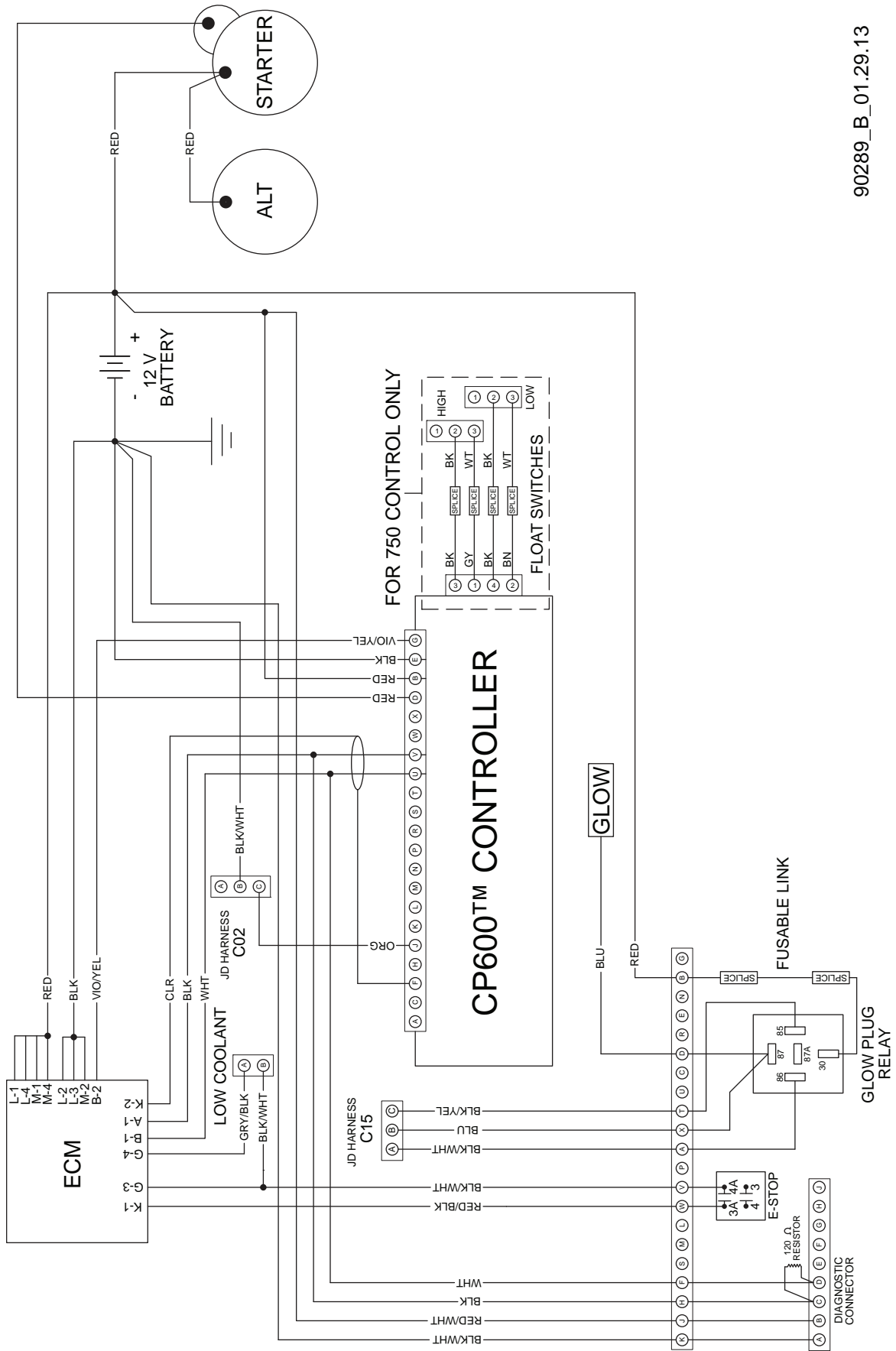

90289_B_01.29.13

TRAILER LIGHTS WIRING DIAGRAM

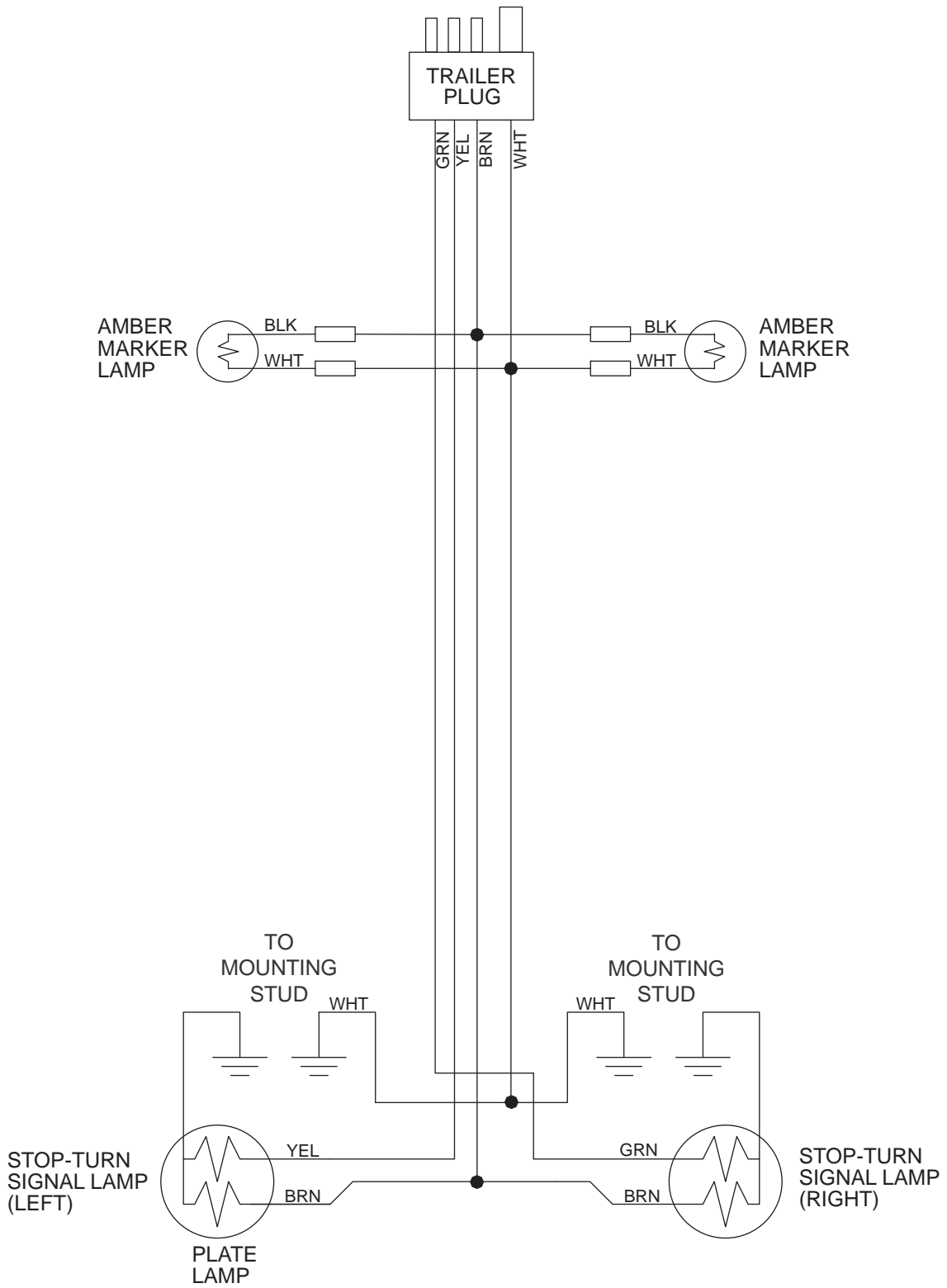

90228_ORG_05.09.12

SERVICE LOG

OIL GRADE: _____ BRAND: _____

COOLANT MIXTURE: _____ BRAND: _____

Date	Hours to service	Oil level	Coolant level

Date	Hours to service	Oil level	Coolant level

REV: C
PART NO: 49521
09.12.13

CANplus and CANplus logo are registered
trademarks of LOFA Industries, Inc.
CP600 is a trademark of LOFA Industries, Inc.